



PRODUCT CATALOGUE

 rodextools.com

  **RODEXTOOLS**





COMBINATION PLIER



CODE	FEATURES	PCS
RHT0301100006	6" 160 MM	60
RHT0301100007	7" 180 MM	60
RHT0301100008	8" 200 MM	60

SIDE CUTTING PLIER



CODE	FEATURES	PCS
RHT0302100006	6" 160 MM	120

LONG NOSE PLIER



CODE	FEATURES	PCS
RHT0303100006	6" 160 MM	120

COMBINATION PLIER



CODE	FEATURES	PCS
RHT0301200006	6" 160 MM	60
RHT0301200007	7" 180 MM	60
RHT0301200008	8" 200 MM	60

SIDE CUTTING PLIER



CODE	FEATURES	PCS
RHT0302200006	6" 160 MM	120

LONG NOSE PLIER



CODE	FEATURES	PCS
RHT0303200006	6" 160 MM	120



COMBINATION PLIER



STEEL
CR-V

55-60
HRC

DIN
5749

CARBON
STEEL

TÜVRheinland®

CODE	FEATURES	PCS
RHT0301300006	6" 160 MM	60
RHT0301300007	7" 180 MM	60
RHT0301300008	8" 200 MM	60

SIDE CUTTING PLIER



STEEL
CR-V

55-60
HRC

DIN
5749

CARBON
STEEL

TÜVRheinland®

CODE	FEATURES	PCS
RHT0302300006	6" 160 MM	120

LONG NOSE PLIER



STEEL
CR-V

55-60
HRC

DIN
5749

CARBON
STEEL

TÜVRheinland®

CODE	FEATURES	PCS
RHT0303300006	6" 160 MM	120

ISOLATED COMBINATION PLIER



1000V

STEEL
CR-V

55-60
HRC

DIN
5749

CARBON
STEEL

TÜVRheinland®

CODE	FEATURES	PCS
RHT0301400006	6" 160 MM	60
RHT0301400007	7" 180 MM	60
RHT0301400008	8" 200 MM	60

ISOLATED SIDE CUTTING PLIER



1000V

STEEL
CR-V

55-60
HRC

DIN
5749

CARBON
STEEL

TÜVRheinland®

CODE	FEATURES	PCS
RHT0302400006	6" 160 MM	60

ISOLATED LONG NOSE PLIER



1000V

STEEL
CR-V

55-60
HRC

DIN
5749

CARBON
STEEL

TÜVRheinland®

CODE	FEATURES	PCS
RHT0303400006	6" 160 MM	120



MINI COMBINATION PLIER



CODE	FEATURES	PCS
RHT0301110005	5" 135 MM	120

MINI SIDE CUTTING PLIER



CODE	FEATURES	PCS
RHT0302110005	4.5" 120 MM	120

MINI LONG NOSE PLIER



CODE	FEATURES	PCS
RHT0303110005	5" 130 MM	120

MINI COMBINATION PLIER



CODE	FEATURES	PCS
RHT0301210005	5" 130 MM	240

MINI SIDE CUTTING PLIER



CODE	FEATURES	PCS
RHT0302210005	4.5" 120 MM	240

MINI LONG NOSE PLIER



CODE	FEATURES	PCS
RHT0303210005	5" 130 MM	240



ADJUSTABLE WRENCH



- » Wide operating range
- » High strength – wear resistance
- » The chrome plating protects the tool from corrosion
- » Slip-resistant grip for secure control of the tool

CODE	FEATURES	PCS
RHT0309200006	6" 150 MM	120
RHT0309200008	8" 200 MM	72
RHT0309200010	10" 250 MM	48
RHT0309200012	12" 300 MM	36

ADJUSTABLE WRENCH



- » Wide operating range
- » High strength – wear resistance
- » The chrome plating protects the tool from corrosion
- » Slip-resistant grip for secure control of the tool

CODE	FEATURES	PCS
RHT0309100006	6" 150 MM	60
RHT0309100008	8" 200 MM	60
RHT0309100010	10" 250 MM	36
RHT0309100012	12" 300 MM	24

PIPE WRENCH TWO HANDLE



- » Straight jaws
- » Jaw hardness - 50 hrc
- » Cast body
- » Painted
- » Strong notches
- » Wide grip

CODE	FEATURES	PCS
RHT0310100001	1" 40 MM	36
RHT0310100015	1-1/2" 55 MM	24
RHT0310100002	2" 67 MM	16

WATERPUMP PLIER



- » Wear resistance
- » Black phosphate coating
- » Adjustable grooved mechanism
- » Slip-resistant grip for secure control of the tool

CODE	FEATURES	PCS
RHT0311200010	10" 250 MM	36

CURVED JAW LOCKING PLIER

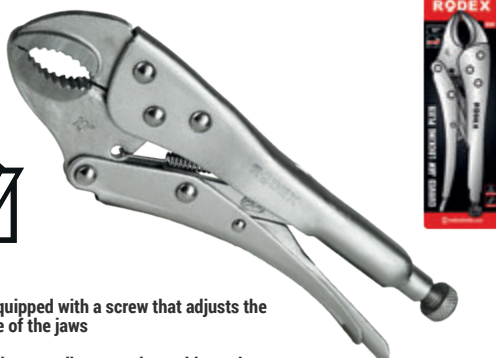

- » The tool is equipped with a screw that adjusts the clamping force of the jaws
- » A special spring contributes to the rapid opening of the tool

CODE	FEATURES	PCS
RHT0307200010	10" 250 MM	48

SOCKET WRENCH SET



CODE	FEATURES	PCS
RHT0202100022	1/4" 22 Pcs.	10



ALLEN KEY SET (9 PCS)



» 1,5-2-2,5-3-4-5-6-8-10MM

CODE	FEATURES	PCS
RHT050110009	Short	80
RHT050110109	Long	40

ALLEN KEY SET (9 PCS)



» T10-T15-T20-T25-T27-T30-T40-T45-T50

CODE	FEATURES	PCS
RHT050111009	Short	80
RHT050111109	Long	40

ALLEN KEY SET (9 PCS) EXTRA LONG



» 1,5-2-2,5-3-4-5-6-8-10MM

CODE	FEATURES	PCS
RHT0501141008	Extra Long	40

ALLEN KEY SET (9 PCS) EXTRA LONG



» T10-T15-T20-T25-T27-T30-T40-T45-T50

CODE	FEATURES	PCS
RHT0501140008	Extra Long	40

ALLEN KEY SET (9 PCS)



» 1,5-2-2,5-3-4-5-6-8-10MM

CODE	FEATURES	PCS
RHT0501120008	Short	80
RHT0501121008	Long	40

ALLEN KEY SET (9 PCS)



» T10-T15-T20-T25-T27-T30-T40-T45-T50

CODE	FEATURES	PCS
RHT0501130008	Short	80
RHT0501131008	Long	40



AVIATION TIN SNIPS

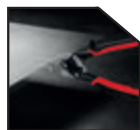

- » Designed to cut up to 1.2mm thickness of sheet metal
- » Blade locking mechanism - safe storage and transportation



CODE	FEATURES	PCS
RHT0603120010	10" 250mm Straight Cut	60
RHT0603120012	12" 300mm Long Cut	48

AVIATION TIN SNIPS



- » Designed to cut up to 1.2mm thickness of sheet metal
- » Blade locking mechanism - safe storage and transportation



CODE	FEATURES	PCS
RHT0603130010	10" 250mm Right Cut	48

AVIATION TIN SNIPS



- » Designed to cut up to 1.2mm thickness of sheet metal
- » Blade locking mechanism - safe storage and transportation



CODE	FEATURES	PCS
RHT0603140010	10" 250mm Left Cut	48

FENCING PLIERS



- » Fencing Pliers are highly versatile thanks to having a hammer to drive fence staples, a main jaw with 40mm jaw capacity to grip staples and pull them out of the post, extra jaws to stretch and splice wires and as an added bonus, includes two wire cutters. Plier has slip-resistant cushion grip handle for convenience in use.



CODE	FEATURES	PCS
RHT0604130105	10,5" 270mm	24

STEEL WIRE ROPE SCISSORS



- » Provides a clean and high quality cut
- » Suitable for cutting all kinds of carbon steel wire rope up to 3 mm in diameter



CODE	FEATURES	PCS
RHT0604100008	8" 200mm	60

MINI BOLT CUTTER



- » Mini bolt cutter can be used to cut wide range of items such as nets, bolts, screws, chain, baling wire, electric wire...
- » Ergonomic handle is non-slip and soft grip.
- » The toughness of the cutting blade is high frequency quenched and heat treated HRC 52.
- » The size of the opening can be adjusted by the nut on the body. Max. opening is 5mm, max cutting capacity is 2.3mm.



CODE	FEATURES	PCS
RHT0604110008	8" 200mm	72



MULTI ANGLE SCISSORS



CODE	FEATURES	PCS
RHT0606200001	8" 45°-135°	40

» Shears are able to cut flat cables, chamfer, round molds, trunking and pvc strips, rubber gaskets, molding and weatherstrip, decorative wood etc.. The product is equipped with a built-in miter ruler with marking of various angles between 45°-135°.

JIG SAW BLADE

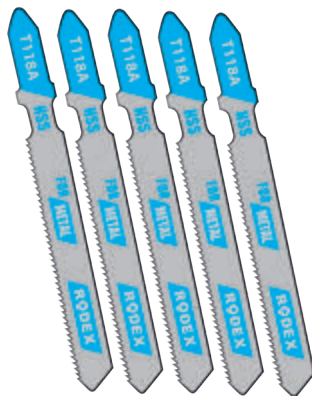

CODE	FEATURES	PCS
RHT0706110118	5 Pcs - 75 mm / T118A	400

JIG SAW BLADE



CODE	FEATURES	PCS
RHT0706100144	5 Pcs - 100 mm / T144D	400

JIG SAW BLADE



CODE	FEATURES	PCS
RHT0706120101	2 Pcs - 76 mm / T101AO	800

JIG SAW BLADE



CODE	FEATURES	PCS
RHT0706130311	2 Pcs - 116 mm / T311C	800



PRUNING SAW WITH COVER

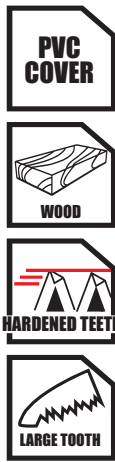

CODE	FEATURES	PCS
RHT0702120030	300 mm Large Tooth	36

PRUNING SAW WITH COVER

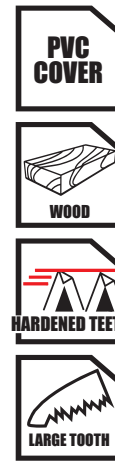

CODE	FEATURES	PCS
RHT0702121030	300 mm Large Tooth	36

FOLDABLE PRUNING SAW

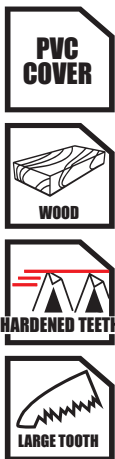

CODE	FEATURES	PCS
RHT0702100018	180 mm Small Tooth	60

FOLDABLE PRUNING SAW

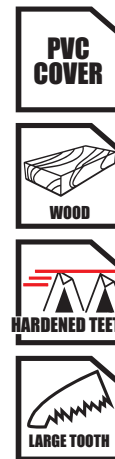

CODE	FEATURES	PCS
RHT0702101018	180 mm Small Tooth	36

HAND RIVETER



CODE	FEATURES	PCS
RHT0403100009	9.5"	24

WELDING MAGNET SET

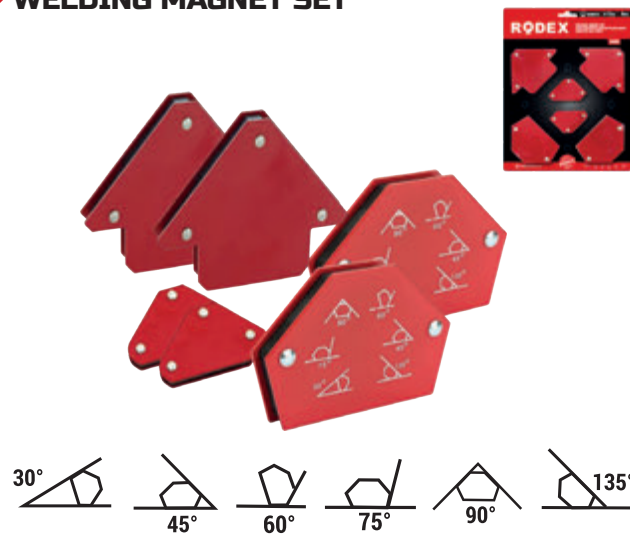

CODE	FEATURES	PCS
RHT0409100006	6 Pcs / 4-12 Kg	10



WIRE STRIPPER



- » Wire stripper is used for easily peeling off the insulation layer without damaging the wire.
- » Long lasting usage and sharpness.
- » Spring lock design is suitable for one hand operation and carriage in toolbox.
- » The handle is made of anti-slip PP + TPR material with comfortable feel and ergonomic design.



CODE	FEATURES	PCS
RHT0401100007	7" / Ø 1.6-3 mm	120

AUTOMATIC WIRE STRIPPER



- » Strip wire with our self-adjusting mechanism.
- » 3 in 1 Function as wire stripping, wire cutting, and crimp insulated and non-insulated terminals.
- » Non-slip PP grip.
- » Stripping size range is 0.5 - 6.0 mm²



CODE	FEATURES	PCS
RHT0401110008	7" / Ø 0.5-6.0 mm	40

AUTOMATIC WIRE STRIPPER



- » Clean strip of wires with ease.
- » Compound action stripping via single-action squeezing motion.
- » Precision machined stripping holes easily remove insulation without damaging the wire.
- » During stripping the wire, jaws gently hold the cable.



CODE	FEATURES	PCS
RHT0401120007	8" / Ø 0.5-6.0 mm	48

WIRE STRIPPER

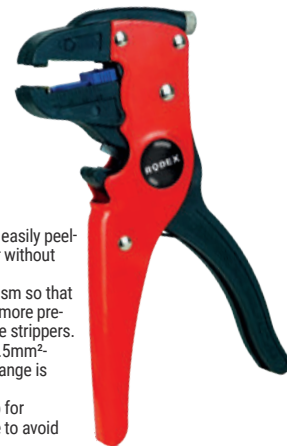

- » Wire stripper is used for easily peeling off the insulation layer without damaging the wire.
- » It has universal mechanism so that it's way easier, faster and more precise than old school gauge strippers.
- » Stripping size range is 0.5mm²-2.5mm² and cutting size range is 3.5mm²
- » Tension adjustable knob for adjusting the pulling force to avoid damaging the wire core.



CODE	FEATURES	PCS
RHT0401130007	175 mm / Ø 0.5-2.5 mm	48

FOLDING UTILITY KNIFE

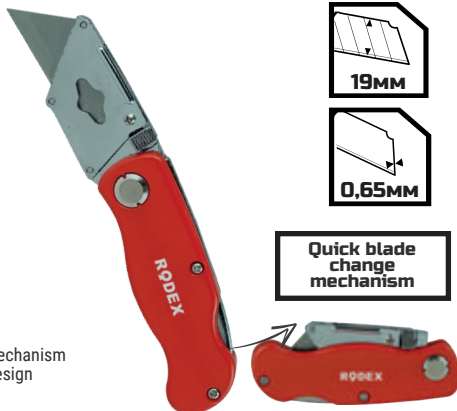
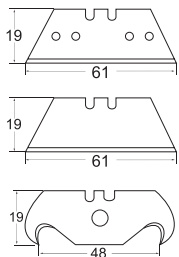

- » Durable metal body
- » Quick blade change mechanism
- » Foldable one button design
- » Metal belt clip



CODE	FEATURES	PCS
RHT0608100001	19mm	144

RHT0608210001	19mm	10/400
---------------	------	--------

CUTTER BLADE

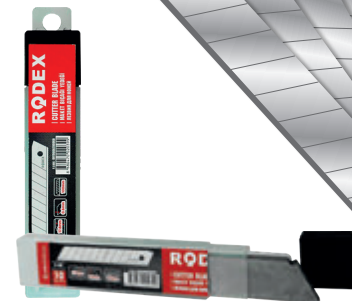

CODE	FEATURES	PCS
RHT0608200008	100x18x 0.6 mm	20/400



TAP AND DIE SET



» The tap and die set is designed to obtain clean external and internal threads
 » Taps and dies are made of steel, which is characterized by high contact strength and wear resistance



CODE	FEATURES	PCS
RHT0312100020	20 Pcs.	20

TAP AND DIE SET



» The tap and die set is designed to obtain clean external and internal threads
 » Taps and dies are made of steel, which is characterized by high contact strength and wear resistance



CODE	FEATURES	PCS
RHT0312100012	12 Pcs.	20

ПЕРЬЕВЫЕ СВЕРЛА ПО ДЕРЕВУ



» These drills drill 4 times faster than standard spade drills and last long due to the thicker cutting edge

CODE	FEATURES	PCS
RHT1002100006	6 Pcs. / 12-16-18-20-22-25 mm	100

GLASS & CERAMIC DRILL BIT



CODE	FEATURES	PCS
RHT1001130004	Diameter 4mm	500
RHT1001130005	Diameter 5mm	500
RHT1001130006	Diameter 6mm	500
RHT1001130008	Diameter 8mm	500
RHT1001130010	Diameter 10mm	500
RHT1001130012	Diameter 12mm	500

STEP DRILL



CODE	FEATURES	PCS
RHT1001100412	4-12 mm	50
RHT1001110420	4-20 mm	100
RHT1001120432	4-32 mm	75





VOLTAGE TESTER



CODE	FEATURES	PCS
RHT0503100014	75 MM (-)	600
RHT0503110014	75 MM (+)	600

SCREWDRIVER SET WITH MAGNETIC TIPS (8 PCS)

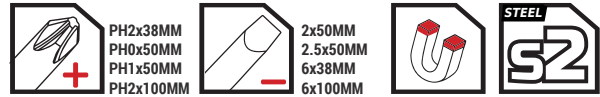

CODE	FEATURES	PCS
RHT0504100008	8 Pcs.	24

WIRE CUP BRUSH



- » The wire material is twist knotted steel.
- » Heavy-duty cleaning of large metal surfaces.
- » Easy and smooth removal of burrs, spatter, weld scale, rust, paint and other debris.

CODE	FEATURES	PCS
RHT1502100065	Wire M14, 65 mm	100
RHT1502100075	Wire M14, 75 mm	80

WIRE CUP BRUSH



- » The wire material is crimped brass-plated steel.
- » Heavy-duty cleaning of metal surfaces.
- » Suitable for cleaning work on medium to large steel surfaces, serving also for the removal of corrosion, paint, light deburring, heavy rust or varnish.

CODE	FEATURES	PCS
RHT1502110065	Wire M14, 65 mm	100
RHT1502110075	Wire M14, 75 mm	80
RHT1502110100	Wire M14, 100 mm	60

WIRE BRUSH



- » The wire material is brass, upper head is steel wire. Handle is PP.
- » Cleans places where strong scrubbing is needed, it helps to remove the welding slag, rust, paint stains, and can clean steel parts, machinery, unfinished metal parts.

CODE	FEATURES	PCS
RHT1501100001	9" 240 mm	120

WIRE BRUSH



- » The wire material is brass, upper head is steel wire. Handle is rubber coated PP.
- » The brass brush is ideal to clean metal surfaces without scratching them, while the steel wire brush is for rust removal.

CODE	FEATURES	PCS
RHT1501110001	8" 200 mm	120



SAFETY GOGGLES



- » Panoramic glass has a double-sided coating
- » The outer hard layer is resistant to abrasion and scratching, the inner one is resistant to splashes of solutions and caustic substances
- » The frame is made of soft and elastic evoprene material
- » The glasses are well ventilated and do not fog

CODE	FEATURES	PCS
RHT1811100001	Transparent	200

SAFETY GOGGLES



- » Panoramic glass has a double-sided coating
- » The outer hard layer is resistant to abrasion and scratching, the inner one is resistant to splashes of solutions and caustic substances
- » The frame is made of soft and elastic evoprene material
- » The glasses are well ventilated and do not fog

CODE	FEATURES	PCS
RHT1811100002	Black	200

SAFETY GOGGLES



- » Panoramic glass has a double-sided coating
- » The outer hard layer is resistant to abrasion and scratching, the inner one is resistant to splashes of solutions and caustic substances
- » The frame is made of soft and elastic evoprene material
- » The glasses are well ventilated and do not fog

CODE	FEATURES	PCS
RHT1811100003	Red	200

SAFETY GOGGLES



- » Panoramic glass has a double-sided coating
- » The outer hard layer is resistant to abrasion and scratching, the inner one is resistant to splashes of solutions and caustic substances
- » The frame is made of soft and elastic evoprene material
- » The glasses are well ventilated and do not fog

CODE	FEATURES	PCS
RHT1811100004	Blue	200

SAFETY GOGGLES



- » Panoramic glass has a double-sided coating
- » The outer hard layer is resistant to abrasion and scratching, the inner one is resistant to splashes of solutions and caustic substances
- » The frame is made of soft and elastic evoprene material
- » The glasses are well ventilated and do not fog

CODE	FEATURES	PCS
RHT1811100005	Black	200



RODEX



AUTO DARKENING WELDING HELMET



- MMA
- TIG
- MIG

- » Lens power control: Automatic
- » Filter: Impact-resistant plastic with 90*35mm actual viewing area
- » Helmet material: PP (Fireproofing)
- » Shade control: DIN 4 / DIN 11
- » Switching time: Light to dark: 1/25000sec. Dark to light: 0.4sec.
- » UV-IR Protection: Up to shade DIN 15 at all time
- » Power supply: Solar cells battery + 1 CR2032 Lithium battery (not replaceable)

CODE	FEATURES	PCS
RHT1809110001	Auto Darkening	20

AUTO DARKENING WELDING HELMET



- MMA
- TIG
- MIG

- » Lens power control: Automatic
- » Filter: Impact-resistant plastic with 93*43mm actual viewing area
- » Helmet material: PP (Fireproofing)
- » Shade control with External Knob: DIN 4 (Grind Mode) / DIN 9-13 (Weld Mode)
- » Sensitivity control and delay time control with a knob.
- » Switching time: Light to dark: 1/25000sec. Dark to light: 0.1-1.0sec.
- » UV-IR Protection: Up to shade DIN 16 at all time
- » Power supply: Solar cells battery + 1 CR2032 Lithium battery (replaceable)

CODE	FEATURES	PCS
RHT1809120001	Auto Darkening	20

AUTO DARKENING WELDING HELMET



- MMA
- TIG
- MIG

- » Lens power control: Automatic
- » Filter: Impact-resistant plastic with 90*32mm actual viewing area
- » Helmet material: PP (Fireproofing)
- » Shade control: DIN 4 / DIN 11
- » Switching time: Light to dark: 1/20000sec. Dark to light: 0.4sec.
- » UV-IR Protection: Up to shade DIN 15 at all time
- » Power supply: Solar cells battery + 1 CR1025 Lithium battery (not replaceable)

CODE	FEATURES	PCS
RHT1809100001	Auto Darkening	24

STAPLER GUN

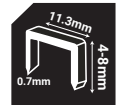
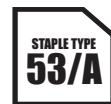

CODE	FEATURES	PCS
RHT1601110468	Wire Width 0.7 mm	48

STAPLER GUN

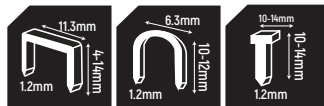

CODE	FEATURES	PCS
RHT1601100414	Wire Width 1.2 mm	24

DEGREASING & UNDERCOATING GUN



- » Working pressure, 3.5 atm
- » Capability to work for a long time without stopping
- » Reliable metal case
- » Light weight for convenience of work

CODE	FEATURES	PCS
RHT1403100001	Capacity , 0.6 lt	20



SPRAY GUN



- » Nozzle diameter, 1,8 mm
- » Connection type, quick coupler (EURO)
- » Air consumption, 200 l/min
- » Air inlet diameter, 1/4"

CODE	FEATURES	PCS
RHT1401110060	Capacity , 0.6 lt	20

SPRAY GUN



- » Nozzle diameter, 1,8 mm
- » Connection type, quick coupler (EURO)
- » Air consumption, 200 l/min
- » Air inlet diameter, 1/4"

CODE	FEATURES	PCS
RHT1401120060	Capacity , 0.6 lt	20

SPRAY GUN



- » Connection type, quick coupler (EURO)
- » Air consumption, 200 l/min
- » Air inlet diameter, 1/4"

CODE	FEATURES	PCS
RHT1401130600	Capacity , 6.0 lt	8

SPRAY GUN



- » Nozzle diameter, 1,8 mm
- » Connection type, quick coupler (EURO)
- » Air consumption, 200 l/min
- » Air inlet diameter, 1/4"

CODE	FEATURES	PCS
RHT1401100100	Capacity , 1.0 lt	10

AIR BLOW GUN



- » Pressure, 7,9 atm
- » Air consumption, 250 l/min
- » Air inlet diameter, 1/4"
- » Metal gun body - for a long service life

CODE	FEATURES	PCS
RHT1402100001	Nose Length 30 mm	50

AIR BLOW GUN



- » Pressure, 7,9 atm
- » Air consumption, 250 l/min
- » Air inlet diameter, 1/4"
- » Metal gun body - for a long service life

CODE	FEATURES	PCS
RHT1402100002	Nose Length 100 mm	50



TILE CUTTING MACHINE WITH INFRARED



- » Solid I-shaped slide rail, provides precise and smooth cut
- » Durable and replaceable tungsten carbide cutting wheel
- » Movable shock-resistant support feet
- » Precise adjustable measuring scale
- » Anti-slip rubber surface, prevents the tiles moving while cutting.

CODE	FEATURES	PCS
RHT1301120060	600 MM "With Laser"	3
RHT1301120080	800 MM "With Laser"	2
RHT1301120100	1000 MM "With Laser"	2

WOODEN CHISEL SET



CODE	FEATURES	PCS
RHT1101200003	12-16-18 MM	48

WOODEN CHISEL



CODE	FEATURES	PCS
RHT1101100016	16 MM	60
RHT1101100018	18 MM	60
RHT1101100020	20 MM	60
RHT1101100024	24 MM	60

F-CLAMP HEAVY DUTY



CODE	FEATURES	PCS
RHT1203100040	400 MM	10
RHT1203100050	500 MM	10
RHT1203100060	600 MM	10
RHT1203100080	800 MM	10
RHT1203100100	1000 MM	10

QUICK RATCHET BAR CLAMP



CODE	FEATURES	PCS
RHT1204100040	150 MM	36
RHT1204100050	200 MM	36
RHT1204100060	300 MM	36
RHT1204100080	450 MM	24
RHT1204100100	600 MM	24

SPRING CLAMP



CODE	FEATURES	PCS
RHT1205100040	50 MM	1000
RHT1205100060	75 MM	600
RHT1205100080	100 MM	200
RHT1205100100	150 MM	100



LASER DISTANCE MEASURER



CODE	FEATURES	PCS
RHT0903100040	40 M	60
RHT0903100060	60 M	60
RHT0903100080	80 M	60
RHT0903100100	100 M	60

MEASURING TAPE



- » Sliding lock design with pull button release allows inner tape extended and retracted smoothly.
- » Suitable for construction, decoration, drawing and other necessary tools for household measurement.

CODE	FEATURES	PCS
RHT0901140316	3M*16MM	120
RHT0901140519	5M*19MM	120
RHT0901140525	5M*25MM	120
RHT0901140725	7.5M*25MM	48
RHT0901140102	10M*25MM	48

MEASURING TAPE



- » Self-locking function, automatic recycling at the push of a button, automatic stop, safe and secure.
- » Suitable for construction, decoration, drawing and other necessary tools for household measurement.

CODE	FEATURES	PCS
RHT0901150316	3M*16MM	240
RHT0901150519	5M*19MM	120
RHT0901150725	7.5M*25MM	48
RHT0901150102	10M*25MM	48

MEASURING TAPE



- » Self-locking function, automatic recycling at the push of a button, press and stop, safe and secure.
- » Suitable for construction, decoration, drawing and other necessary tools for household measurement.

CODE	FEATURES	PCS
RHT0901160316	3M*16MM	180
RHT0901160519	5M*19MM	120
RHT0901160525	5M*25MM	120
RHT0901160102	10M*25MM	60

LONG STEEL MEASURING TAPE



- » Impact-resistant heavy duty ABS frame
- » Nylon coated reinforced tape for maximum durability
- » Open reel stainless steel tape
- » Cone tip stake for accurate measurements and stability

CODE	FEATURES	PCS
RHT0902100030	30M*25MM	10
RHT0902100050	50M*25MM	10



4D 16 LINE LASER LEVEL



- » Self leveling system.
- » Can be used in Indoor and outdoor works.
- » 4 laser diodes with a wavelength of 532 nm.
- » Less than 1W energy consumption.
- » High level of accuracy.
- » Protection against dust and moisture: IP54;
- » Easy to store and carry with its storage bag.
- » Working time on a single charge: 3-4 hours.
- » Can be mounted on a 1/4" threaded tripod.



CODE	FEATURES	PCS
RHT0908140416	20-30 m, 16 Line	10

5 LINE LASER LEVEL



5 LINE

- » Can be mounted on a 1/4" threaded tripod.

CODE	FEATURES	PCS
RHT0908100520	10-20m, 5 Line	12

5 LINE LASER LEVEL

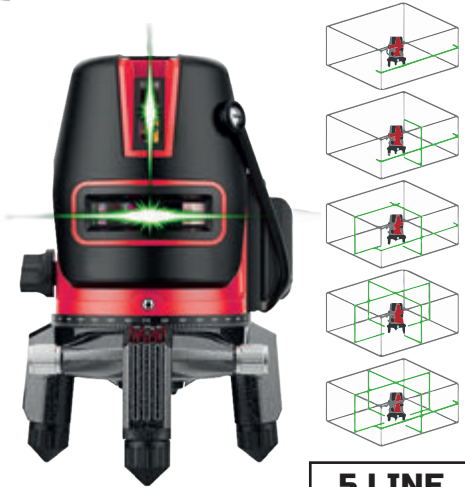

5 LINE

- » Can be mounted on a 1/4" threaded tripod.

CODE	FEATURES	PCS
RHT0908110530	15-30m, 5 Line	12

5 LINE LASER LEVEL



5 LINE

- » Can be mounted on a 1/4" threaded tripod.

CODE	FEATURES	PCS
RHT0908120535	20-35m, 5 Line	12

TRIPOD

1/4"
SCREW MOUNT



CODE	FEATURES	PCS
RHT0908130012	1.2 m	30



SPIRIT LEVEL ALUMINIUM



» Professional spirit level for easy leveling: horizontal accuracy at 180°, vertical accuracy at 90°, and 45° accuracy – all with a high level of precision: ±0.5mm/m

» Shock-absorbing end caps of the torpedo level hold up to heavy use

» Aluminum frame provides long-lasting strength

» Powerful magnetic and milled edge for convenient, hands-free use

CODE	FEATURES	PCS
RHT0904140040	400MM	30
RHT0904140050	500MM	30
RHT0904140060	600MM	30
RHT0904140080	800MM	30
RHT0904140100	1000MM	30

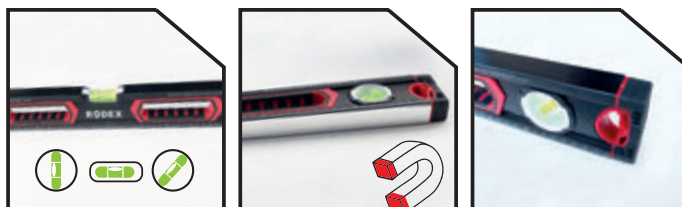

L TYPE RULER HEAVY DUTY



CODE	FEATURES	PCS
RHT0906100025	250MM	60
RHT0906100030	300MM	60
RHT0906100040	400MM	60
RHT0906100050	500MM	60

MINI SPIRIT LEVEL



CODE	FEATURES	PCS
RHT0904130001	85 * 20 * 45.5MM	240

L TYPE RULER WITH BUBLE

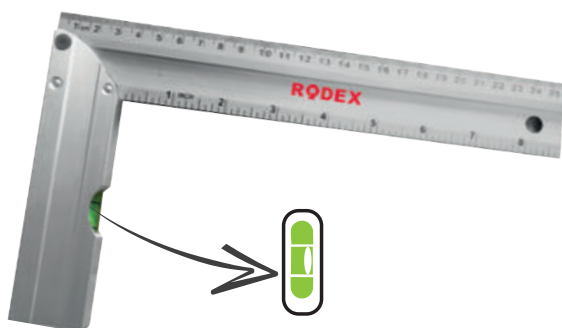

CODE	FEATURES	PCS
RHT0906110025	250MM	60
RHT0906110030	300MM	60
RHT0906110035	350MM	60
RHT0906110040	400MM	60
RHT0906110050	500MM	60
RHT0906110060	600MM	60

RULER

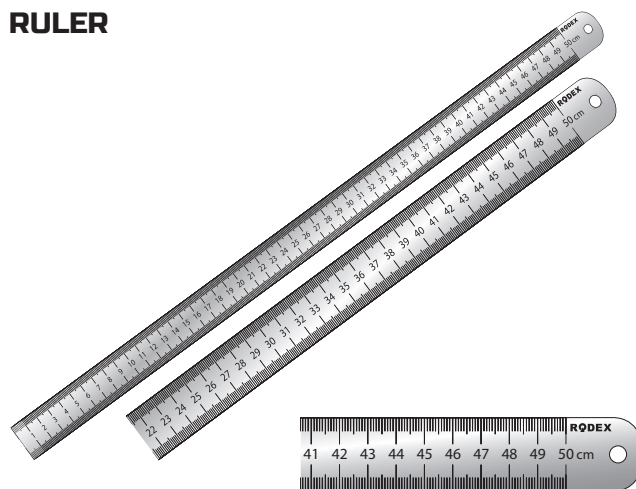

CODE	FEATURES	PCS
RHT0907100050	500MM	300
RHT0907100100	1000MM	120



HAMMER WITH WOODEN HANDLE



- » Made of special alloy steel
- » Induction hardened
- » Electrostatic powder painted
- » Ergonomic wooden handle
- » The hammer has a shape that goes from rectangular to triangular.
- » The thick part is used for driving nails, while the pointed part is used to hollow an area or break an area and object.

CODE	FEATURES	PCS
RHT0801100010	100 Gr	120
RHT0801100020	200 Gr	72
RHT0801100030	300 Gr	60
RHT0801100050	500 Gr	48
RHT0801100080	800 Gr	24
RHT0801100100	1000 Gr	24
RHT0801100150	1500 Gr	12
RHT0801100200	2000 Gr	12



FORGED CLAW HAMMER



50-58
HRC

DIN
1193



- » Full-fledged casting steel
- » Long lifetime even under difficult conditions

CODE	FEATURES	PCS
RHT0802100016	16 OZ (454 Gr)	36
RHT0802100020	20 OZ (567 Gr)	24

FORGED STRAIGHT JAW CLAW HAMMER



50-58
HRC

DIN
7239



- » Full-fledged casting steel
- » Long lifetime even under difficult conditions

CODE	FEATURES	PCS
RHT0802110016	16 OZ (454 Gr)	36
RHT0802110020	20 OZ (567 Gr)	24

ROOFING HAMMER



50-58
HRC

DIN
7239



- » It is used in roofing works with thin sheet metal
- » Suitable for trimming roof edges and fixing to roof frame.
- » Also Ideal claw hammer for driving nails, ripping out nails, wood work, framing, and punching holes in drywall and shingles
- » Features a pointed rip claw to pull nails and puncture holes in sheet metal and other materials
- » Fiberglass handle is immersed in non-slip rubberized grip
- » Head includes a cut-out and magnet to start nails safely with a quick tap

CODE	FEATURES	PCS
RHT0803100020	20 OZ (567 Gr)	24

MINI CLAW HAMMER



50-58
HRC

DIN
1193



- » Made from high density carbon steel, anti-rust and durable
- » Ergonomic, non-slip, soft rubber, fiber handle
- » Perfect size, easy to carry, convenient for work
- » Ideal for woodworking, DIY Projects, either at home or workshop

CODE	FEATURES	PCS
RHT0802130008	8 OZ (226 Gr)	24



WELDERS CHIPPING HAMMER



50-58
HRC



» High carbon steel chipping hammer's spring handle is designed to absorb the shock of contact while cleaning welding debris.
 » One end is a flat chisel and the other end is a conical chisel to get into tight spots. Used for removing slag and welding residue.

CODE	FEATURES	PCS
RHT0804100050	18 OZ (500 Gr)	24

STONE HAMMER



50-58
HRC

DIN
6475



» Forged in one-piece steel structure prevents the head from falling off
 » Perfectly balanced to deliver powerful blows with an easy swing
 » The ergonomic handle can absorb shock and vibration to achieve a comfortable touch and reduce hand fatigue

CODE	FEATURES	PCS
RHT0805100300	3.0 LB (1.36 Kg)	12

AXE WITH FIBERGLASS HANDLE



50-58
HRC

DIN
5131

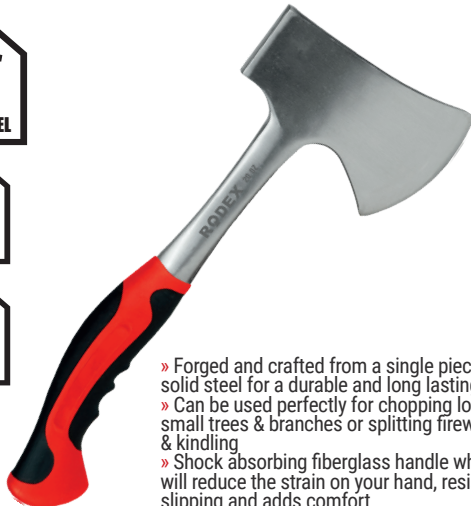

» Forged and crafted from a single piece of solid steel for a durable and long-lasting use
 » Can be used perfectly for chopping logs, small trees & branches or splitting firewood & kindling
 » Shock absorbing fiberglass handle which will reduce the strain on your hand, resists slipping and adds comfort

CODE	FEATURES	PCS
RHT0808100020	20 OZ (567 Gr)	24

AXE WITH FIBERGLASS HANDLE



50-58
HRC

DIN
5131



» Forged carbon steel heat-treated blade provides smooth, sharp and quick splits and stays sharp long.
 » Can be used perfectly for chopping logs, small trees & branches or splitting firewood & kindling
 » Shock absorbing fiberglass handle which will reduce the strain on your hand, resists slipping and adds comfort

CODE	FEATURES	PCS
RHT0808110150	1500 Gr	12

RHT1906100001 Tool Bag



» 34*22*25 cm

600D
POLYESTER

14"

PCS
25

RHT1906110001 Tool Belt



600D
POLYESTER

» 13*23 cm

PCS
50

RHT1906130001 Tool Belt



600D
POLYESTER

» 56*16 cm

PCS
50

RHT1906120001 Drill Holster



600D
POLYESTER

» 25*15 cm

PCS
100



İstoç Ticaret Merkezi 2416 Sk. AKTEM PLAZA
13.Kat Bağcılar / İstanbul TÜRKİYE
+90 212 771 04 66
info@aktekLtd.com
www.aktekLtd.com

   AktekLtd

Aktek

FOREIGN TRADE COMPANY