

# KLAUS<sup>®</sup>

 [klauselectric.com](http://klauselectric.com)



# ANURA

 [anuraelectric.com](http://anuraelectric.com)

# TABLE OF CONTENTS



## Led Lamps 6 - 27

Led Lamp, **Industrial Led Bulb**, Rechargeable Led Bulb, **Led Filament Bulb**, C37 Led Filament Bulb, **Led T Bulb**, Radar Sensor Led Lamp, **MR16 Led Spotlight**, G45 Led Lamp, **Led Reflector Lamp**, Colored Led Bulb, **Flame Led Lamp**, Fan Blade Led Lamp, **Foldable Ball Led Lamp**, Led Candle Lamp, **Led Candle Tailed Lamp**, Led Downlight



## Led Floodlights 28 - 38

Smd Led Floodlight, **Smd Ultra Slim Led Floodlight With Sensor**, Smd Ultra Slim Led Floodlight, **Module Led Floodlight**, Smd Led Slim Floodlight, **Smd Led Floodlight With Tripod**, Rechargeable Led Floodlight, **Rechargeable Led Slim Floodlight**



## Led Street Lights, Wall Lights, 39 - 63 Highways, Tubes, Fixtures, Bulkheads, Panels

SMD Led Street Light, **COB Led Street Light**, Solar Led Street Light, **Led Wall Light With Sensor**, Solar Led Wall Light, **Led Wall Spotlight With Sensor**, Led Fixture, **Led Glass Tube**, Frameless Recessed Led Panel, **Frameless Surfaced Led Panel**, Round Led Panel Light Recessed, **Square Led Panel Light Recessed**, Round Led Panel Light Surfaced, **Square Led Panel Light Surfaced**, Square Led Panel Back Light Surfaced



## Ceiling Lights, Smart Lights, 64 - 80 Strip Leds, Garden Lights

Led Downlight, **Led Ray Spotlight**, MR16 Round Glass Frame, **MR16 Square Glass Frame**, Downlight Casing, **Led Bulb Smart Light**, Ceiling Lamp Smart Light, **Strip Leds**, Led Ceiling Light, **Outdoor Led Lighting**, Underground Led Lamp, **Garden Spike Lamp**, Wall Light, **Garden Light**, Step Light



## Ventilation Equipments, Circuit Breakers, 81 - 108 Table Lamps, Flashlights, Accessories

Front&Back Shutter Exhaust Fan, **Exhaust Fan**, Stand Fan, **Ceiling Fan**, Miniature Circuit Breaker, **Residual Current Circuit Breaker**, Table Lamp, **Led Rechargeable Emergency Lamp**, Rechargeable Flashlight, **Camp Light**, Night Lamp, **Flashlight**, Headlight, **Terminal Block Slot Screw**, Cable Clip, **Wire Connect**, Network Cable, **Heat Shrink Tube**, Insulated Terminal, **Lamp Holder & With Sensor**, Photocell, **Pir Sensor**, Automatic Switch Boxes For Outdoor&Indoor



## KLAUS Sockets & Switches 110 - 124

One-Two-Triple Way Switch, **One-Two Way Switch Illuminated**, Dimmer Switch, **Vavien Switch**, Socket Outlet, **Numeric Telephone Socket**, Data+Phone Socket, **TV Antenna Socket**, TV Sat Socket, **Single-Double-Triple-4 Gang-5 Gang Frame**



## ANURA Sockets & Switches 125- 164

One-Two-Triple Way Switch, **One-Two Way Switch Illuminated**, Dimmer Switch, **Vavien Switch**, Socket Outlet, **Numeric Telephone Socket**, Data+Phone Socket, **TV Antenna Socket**, TV Sat Socket, **Single-Double-Triple-4 Gang-5 Gang Frame**, Circuit Breakers, **Accessories**,

TURKEY | UNITED KINGDOM | ITALY | BOSNIA | SERBIA | UKRAINE | MOLDOVA | BULGARIA  
ROMANIA | ALBANIA | TAJIKISTAN | KAZAKHSTAN | UZBEKISTAN | KYRGYZSTAN | GEORGIA | ARMENIA  
IRAQ | JORDAN | SAUDI ARABIA | UAE | LIBYA | TANZANIA | MALAWI | OMAN | MOZAMBIQUE

Turkey

Discover  
the potential

### Quality / Качество

The quality mark of the KLAUS ELECTRIC Turkish company that controls production. KLAUS has an executing way of never abandoning on the service and item quality, always focusing on customer requirements and conveying the service on time.

Знак качества турецкой компании KLAUS ELECTRIC, которая следит за производством. В компании Клаус всегда соблюдаются 2 правила: никогда не экономить на качестве и обслуживании продукции; 2. всегда сосредотачиваться на требованиях клиента и предоставлять услуги вовремя



### Technology / Технология

R&D activities on our current items and new items continue as fast as possible. Any kind of innovations and developments on lighting area are being observed closely and formed and contributed in accordance with all markets requirements where we operate with KLAUS brand.

Научно-исследовательская работа по нашей новой продукции происходит всегда. Любая инновация в области осветительного оборудования глубоко изучается нашими экспертами и применяется в производстве.



### Energy Saving / Энергосбережение

Led bulb models contribute to energy saving of 90% comparing to the old fashion lighting methods whereas CFL models do it by 50%.

Энергосберегающие модели лампочек КЛАУС экономят энергию, сохраняя до 90%, если сравнивать со старыми осветительными моделями, которые сохраняют только до 50% энергии.





### Durability / Длительность

The product life time is long term based on the quality of the materials used on production and proper use of the instructions

Продолжительность жизни нашей продукции очень длительная благодаря качеству материалов, которые используются в производстве, а также правильному использованию с соответствии с инструкцией.



	 <b>LED</b> Светодиодная Лампа	 <b>ENERGY SAVING</b> Энергосберегающая Лампа	 <b>FILAMENT</b> Лампа Накаливания
<b>LUMEN EFFICIENCY</b> СВЕТОВАЯ ОТДАЧА  450 300 - 900 1100 - 1300 1600 - 1800 2600 - 2800	4 - 5 WATT 6 - 8 WATT 9 - 13 WATT 16 - 20 WATT 25 - 28 WATT	8 - 12 WATT 13 - 18 WATT 18 - 22 WATT 23 - 30 WATT 30 - 55 WATT	40 WATT 60 WATT 75 WATT 100 WATT 150 WATT
<b>PROS AND CONS</b> ПРЕИМУЩЕСТВА И НЕДОСТАТКИ  LIFE TIME Использование на протяжении жизни FREQUENTLY ON/OFF Частота Включения / Выключения INSTANT BRIGHTNESS Мгновенная Яркость DURABILITY Длительность HEAT EMISSION Тепло от вредных веществ HEAT SENSITIVITY Чувствительность к теплу HUMID SENSITIVITY Чувствительность к влажности HAZARDOUS MATERIAL Опасный материал CHANGING FREQUENCY Частота Смены	50000 HOURS  NO AFFECT  YES  DURABLE  LESS ( 3 btu's/hr )  NO  NO  NO  1	8000 - 10000 HOURS  SHORTEN ITS LIFE  DELAY  FRAGILE  MID ( 30 btu's/hr )  YES  YES  5 mg MERCURY / LAMP  5	1200 HOURS  AFFECTS LESS  YES  FRAGILE  MUCH ( 85 btu's/hr )  LESS  LESS  NO  40+





## Elements Of The Table / Элементы Таблицы

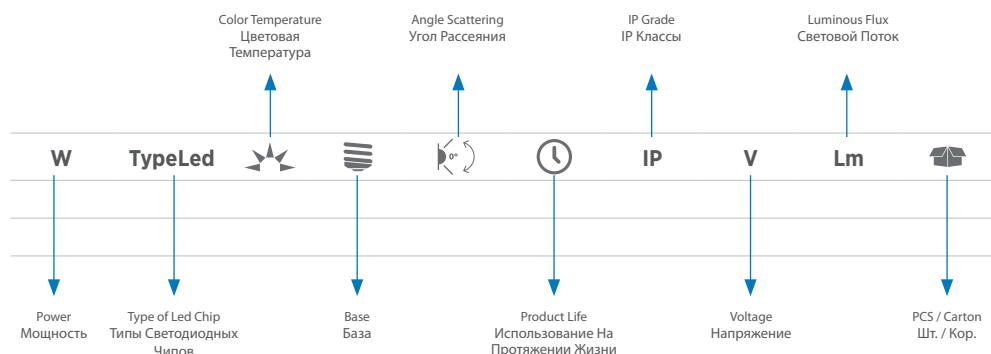

## International Signs / Международные Знаки



Free of liquid mercury. Product compliance with all EU RoHS requirements ( Restriction of Hazardous Substances )

Свободный от жидкой ртути соблюдение требований к продуктам EU RoHS (Ограничение опасных субстанций).



Free of liquid mercury

Свободный от жидкой ртути



Product compliance with all requirements of EU directives. CE mark is a direct evidence of product safety

Соблюдение всех требований Европейских направлений к продуктам. CE оценка это прямое доказательство безопасности продукта.



Instant lighting at switching on

Мгновенное включение освещения



100% luminous flux throughout the service life

100% Яркий световой поток, прослужит долго



100° (Detection angle, provided that it is installed on the wall) 360° (detection angle, provided that it is installed on the ceiling)

100° (Обнаружение угла, который был предоставлен для установки на стене) 360° (Обнаружение угла, который был предоставлен для установки на потолке)

IP Code is a degree of protection against exterior impacts under the European countries regulations. The first digit (from 0 to 6) means the level of protection against ingress of exterior items and dust, the second digit (from 0 to 8) means resistance to the impact of moisture. The higher the digit, the higher the resistance degree.

IP код - Это степень защиты против внешнего воздействия правил Европейских Стран. Первая цифра (0-6) значит уровень защиты против входа внешних предметов (вещей) и пыли, вторая цифра (от 0 до 8) значит сопротивление воздействию влажности чем выше цифра, тем выше степень сопротивления.



Sensors are intended only for internal lighting of premises. They are not intended for use in operating permises with increased content of dust moisture

Датчики предназначены только для внутренних ответительных приборов в помещении. Они не предназначены для использования в оперировании помещениями с увеличенным содержанием пыли и влаги.



Sensors with protection against ingress of dust with the size over 1mm, drops and splashes that fall on the body at any angle

Датчики с защитой против входа пыли с размером более 1 мм, каплей и брызгов которые падают на поверхность любого угла



Sensors with full protection against ingress of dust, drops ans splashes that fall on the body at any angle

Датчики с полной защитой против входа пыли, каплей и брызгов что попадают на поверхность любого угла

## Watts - Ватт

### Watts

A watt is a measurement of electrical power, formally equal to the amount of energy in 1 ampere of current flowing at 1 volt. A light bulb that is rated at, say, 200 watts use more electricity to produce light than a bulb rated for 100 watts.

### Ватт

Ватт - Это единица измерения электрической силы, формально равная единице измерения 1 ампер протекающего тока. Лампочка, оцененная в 200 ватт, расходует больше электричества, чтобы произвести свет, чем лампочка в 100 ватт.

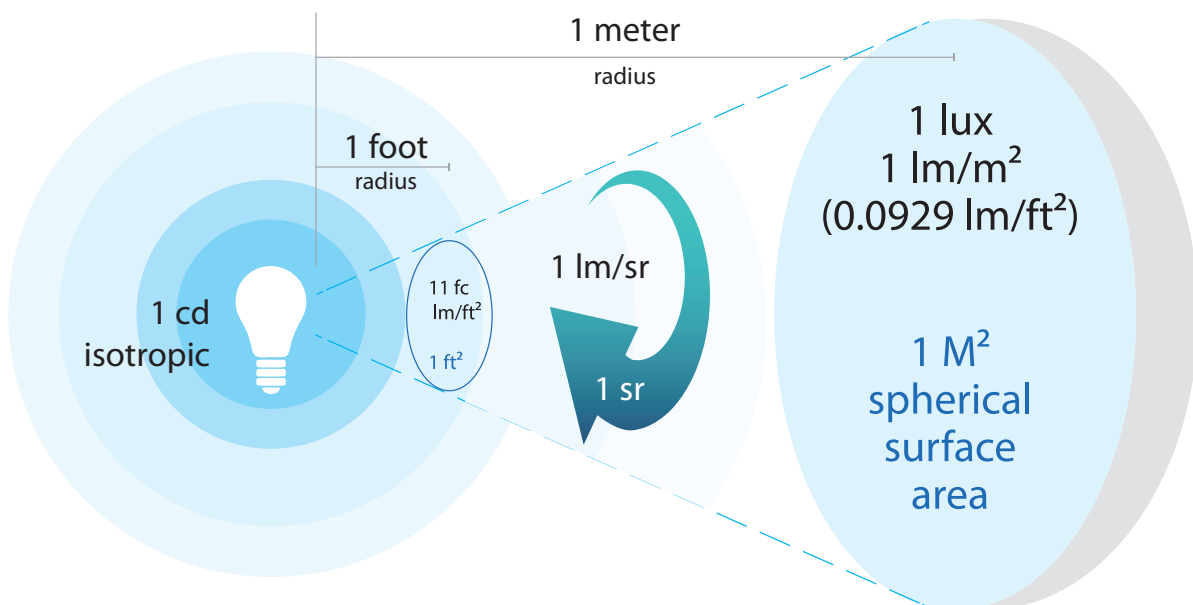

## Luminance - Яркость

### Luminance

Luminance  $L$  is the luminous intensity emitted by the surface area of  $1 \text{ cm}^2$  (or  $1 \text{ m}^2$ ) of the light source.

### Luminous Flux

Luminous flux is the quantity of the energy of the light emitted per second in all directions. The unit of luminous flux is lumen (lm).

### Яркость

Это - Световая интенсивность выходящая на поверхность территории 1 см (или 1 м<sup>2</sup>) световым источником.

### Светой Поток

Это - Количество энергии выходящего света во всех направлениях за секунду.

# KLAUS<sup>®</sup>

[www.klauselectric.com](http://www.klauselectric.com)

**Led Lamps**





## LED LAMP

- \* High Lumen Efficiency
- \* Provides Energy Saving
- \* Long Life Time

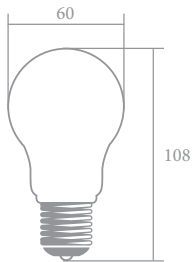

**A+**

Energy Saving



Thermoplastic Body



Eco Friendly

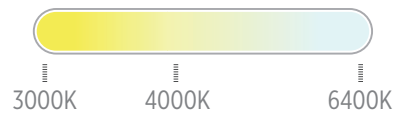

P. Code	W	TypeLed	☀	≡	⌚	⌚	IP	V	lm	Size (mm)	☔
KE48601	5W	SMD2835	6400 K	E27	270	25000	20	AC 90-265 V	450	60x109	100
KE48611	5W	SMD2835	4000 K	E27	270	25000	20	AC 90-265 V	450	60x109	100
KE48621	5W	SMD2835	3000 K	E27	270	25000	20	AC 90-265 V	450	60x109	100
KE48602	7W	SMD2835	6400 K	E27	270	25000	20	AC 90-265 V	630	60x109	100
KE48612	7W	SMD2835	4000 K	E27	270	25000	20	AC 90-265 V	630	60x109	100
KE48622	7W	SMD2835	3000 K	E27	270	25000	20	AC 90-265 V	630	60x109	100
KE48603	9W	SMD2835	6400 K	E27	270	25000	20	AC 90-265 V	810	60x109	100
KE48613	9W	SMD2835	4000 K	E27	270	25000	20	AC 90-265 V	810	60x109	100
KE48623	9W	SMD2835	4000 K	E27	270	25000	20	AC 90-265 V	810	60x109	100
KE48604	12W	SMD2835	6400 K	E27	270	25000	20	AC 90-265 V	1080	60x118	100
KE48614	12W	SMD2835	4000 K	E27	270	25000	20	AC 90-265 V	1080	60x118	100
KE48624	12W	SMD2835	3000 K	E27	270	25000	20	AC 90-265 V	1080	60x118	100





## LED LAMP

High Efficiency ✱

High Color Rendering Index ✱

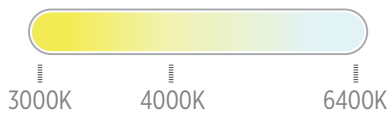

Day & Warm  
Light

**A+**

Energy  
Saving



Thermoplastic  
Body



Eco  
Friendly

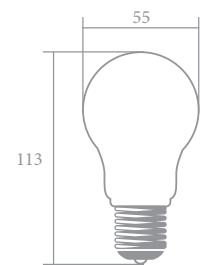

P. Code	W	TypeLed					IP	V	lm	Size (mm)	
KE48605	15W	SMD2835	6400 K	E27	270	25000	20	AC 90-265 V	1350	65x134	100
KE48615	15W	SMD2835	4000 K	E27	270	25000	20	AC 90-265 V	1350	65x134	100
KE48625	15W	SMD2835	3000 K	E27	270	25000	20	AC 90-265 V	1350	65x134	100
KE48606	18W	SMD2835	6400 K	E27	270	25000	20	AC 90-265 V	1620	80x156	50
KE48616	18W	SMD2835	4000 K	E27	270	25000	20	AC 90-265 V	1620	80x156	50
KE48626	18W	SMD2835	3000 K	E27	270	25000	20	AC 90-265 V	1620	80x156	50



## INDUSTRIAL LED BULB

- \* High Lumen Efficiency
- \* Provides Energy Saving

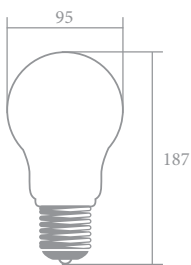

Day Light

**A+**

Energy Saving



Thermoplastic Body



Eco Friendly

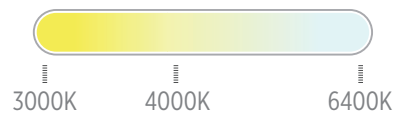

P. Code	W	TypeLed	☀	≡	↻	🕒	IP	V	lm	Size (mm)	🔍
KE48607	22W	SMD2835	6500 K	E27	270	25000	20	AC 100-265 V	1760	95x187	30
KE48617	22W	SMD2835	6500 K	E27	270	25000	20	AC 100-265 V	1760	95x187	30
KE48608	25W	SMD2835	6500 K	E27	270	25000	20	AC 100-265 V	2000	95x187	40
KE48618	25W	SMD2835	6500 K	E27	270	25000	20	AC 100-265 V	2000	95x187	40
KE48609	30W	SMD2835	6500 K	E27	270	25000	20	AC 100-265 V	2400	120x235	30
KE48619	30W	SMD2835	6500 K	E27	270	25000	20	AC 100-265 V	2400	120x235	30



## RECHARGEABLE LED BULB

High Efficiency ✨

Practical Usage ✨



Lithium Battery  
1200mAh

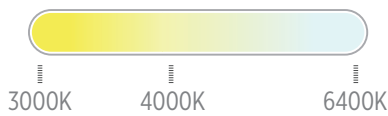

Day Light

**A+**

Energy Saving



Thermoplastic Body



Eco Friendly

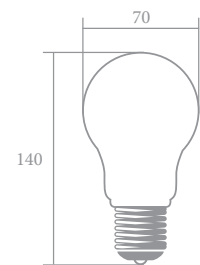

P. Code	W	TypeLed	☀️	≡	🔊	🕒	IP	V	lm	Size (mm)	📦
KE49903	9W	SMD2835	6500 K	E27	270	25000	20	AC 100-265 V	720	70x140	50
KE49904	12W	SMD2835	6500 K	E27	270	25000	20	AC 100-265 V	960	70x140	50



# KLAUS®

[www.klauselectric.com](http://www.klauselectric.com)



**Led Filaments**





## LED FILAMENT BULB

- High Lumen Efficiency ✱
- Strong Warm Light ✱
- Edison Style ✱

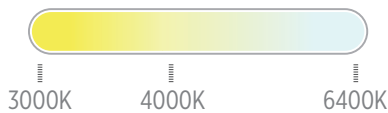
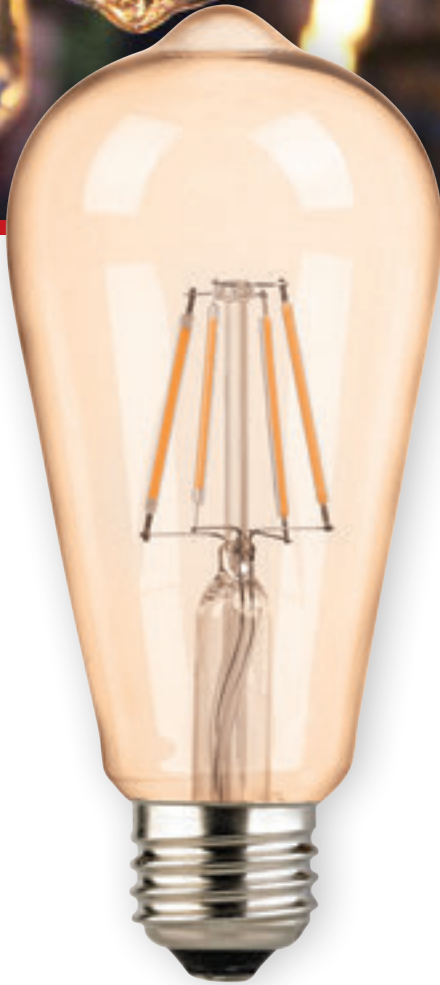

Warm Light

**A+**

Energy Saving



Glass Body



Eco Friendly

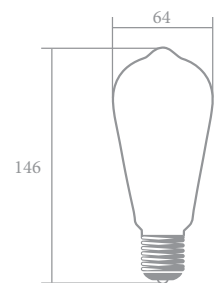

P. Code	W	TypeLed	☀️	🌀	🔊	🕒	IP	V	lm	Size (mm)	🏠
KE48701	6W	Led Filament	2700 K	E27	360	35000	22	AC 170-240V	660	146x64	100



## LED FILAMENT BULB

- \* High Efficiency
- \* Decorative Bulb

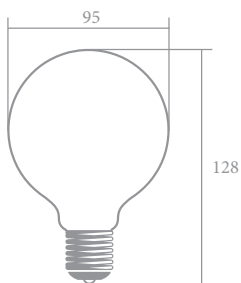

Warm Light

**A++**

Energy Saving



Glass Body



Eco Friendly

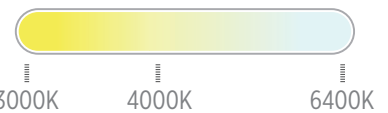

P. Code	W	TypeLed	☀	☰	⚡	🕒	IP	V	lm	Size (mm)	🔍
KE48702	6W	Led Filament	2700 K	E27	360	35000	22	AC 170-240V	660	95x128	40
KE48703	8W	Led Filament	3000 K	E27	360	35000	22	AC 170-240V	880	125x172	20



## LED FILAMENT BULB

High Efficiency ✨

Retro & Decorative Design ✨

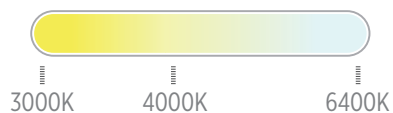

Day & Warm Light   
 Energy Saving   
 Glass Body   
 Eco Friendly

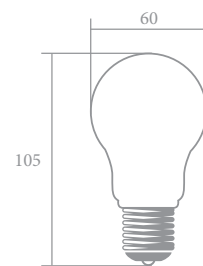

P. Code	W	TypeLed	☀️	⊞	⌚	⌚	IP	V	lm	Size (mm)	⊞
KE48203	6W	Led Filament	6500 K	E27	360	25000	20	AC 185-265V	650	60x105	100
KE48213	6W	Led Filament	3000 K	E27	360	25000	20	AC 185-265V	650	60x105	100



## C37 LED FILAMENT BULB

- \* Strong Lighting
- \* Decorative Candle Bulb

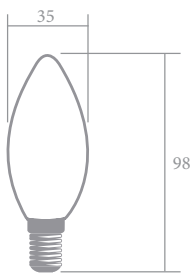

Day & Warm Light

**A++**

Energy Saving



Glass Body



Eco Friendly



3000K

4000K

6400K

P. Code	W	TypeLed	☀	☰	⚡	🕒	IP	V	lm	Size (mm)	🏠
KE49302	4W	Led Filament	6500 K	E14	180	25000	20	AC 185-265V	450	35x98	100
KE49312	4W	Led Filament	3000 K	E14	180	25000	20	AC 185-265V	450	35x98	100





## LED T BULB

- High Lumen Efficiency ✱
- Durable Body ✱
- Long Life Time ✱

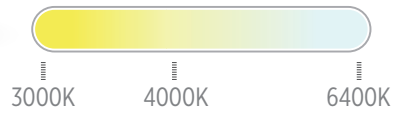

B22



Day Light

**A+**

Energy Saving



Thermoplastic Body



Eco Friendly



20W



30W



40W



50W

P. Code	W	TypeLed	☀️	☰	🔌	🕒	IP	V	lm	Size (mm)	🏠
KE48802	20W	SMD2835	6500 K	E27	270	20000	20	AC 100-265 V	1650	78x138	50
KE48803	30W	SMD2835	6500 K	E27	270	20000	20	AC 100-265 V	2250	100x167	20
KE48804	40W	SMD2835	6500 K	E27	270	20000	20	AC 100-265 V	3240	125x200	30
KE48805	50W	SMD2835	6500 K	E27	270	20000	20	AC 100-265 V	4320	140x210	30
KE48806	60W	SMD2835	6500 K	E27	270	20000	20	AC 100-265 V	5400	140x210	20
KE48802B	20W	SMD2835	6500 K	B22	270	20000	20	AC 100-265 V	1650	78x138	50
KE48803B	30W	SMD2835	6500 K	B22	270	20000	20	AC 100-265 V	2250	100x167	20
KE48804B	40W	SMD2835	6500 K	B22	270	20000	20	AC 100-265 V	3240	125x200	30
KE48805B	50W	SMD2835	6500 K	B22	270	20000	20	AC 100-265 V	4320	140x210	30
KE48806B	60W	SMD2835	6500 K	B22	270	20000	20	AC 100-265 V	5400	140x210	20

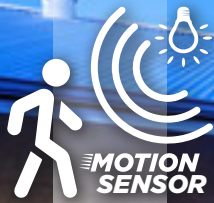

## RADAR SENSOR LED LAMP

- \* Strong Day Light
- \* Radar Light Detection

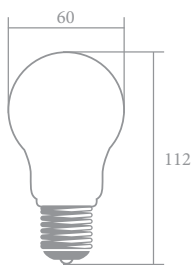

Day Light

**A+**

Energy Saving



Thermoplastic Body



Eco Friendly

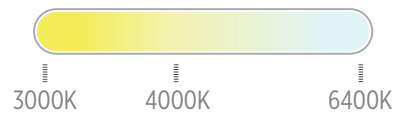

P. Code	W	TypeLed					IP	V	lm	Size (mm)	
KE55102	9W	SMD2835	6500 K	E27	180	25000	20	AC 85-265V	750	60x112	100



# MR16 LED SPOTLIGHT

Strong Day & Warm Light ✨

Durable Heat Resistant Plastic ✨

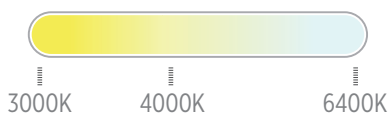

Day & Warm Light

**A+**

Energy Saving



Thermoplastic Body



Eco Friendly

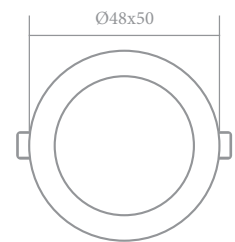

P. Code	W	TypeLed	☀️	☰	↻	🕒	IP	V	lm	Size (mm)	🏠
KE08401	5W	SMD2835	6500 K	GU5.3	120	25000	20	AC 95-265V	400	50x50	200
KE08402	7W	SMD2835	6500 K	GU5.3	120	25000	20	AC 95-265V	560	50x50	200
KE08411	5W	SMD2835	4500 K	GU5.3	120	25000	20	AC 95-265V	400	50x50	200
KE08412	7W	SMD2835	4500 K	GU5.3	120	25000	20	AC 95-265V	560	50x50	200
KE08421	5W	SMD2835	3000 K	GU5.3	120	25000	20	AC 95-265V	400	50x50	200
KE08422	7W	SMD2835	3000 K	GU5.3	120	25000	20	AC 95-265V	560	50x50	200
KE08401U	5W	SMD2835	6500 K	GU10	120	25000	20	AC 95-265V	400	50x50	200
KE08402U	7W	SMD2835	6500 K	GU10	120	25000	20	AC 95-265V	560	50x50	200
KE08411U	5W	SMD2835	4500 K	GU10	120	25000	20	AC 95-265V	400	50x50	200
KE08412U	7W	SMD2835	4500 K	GU10	120	25000	20	AC 95-265V	560	50x50	200
KE08421U	5W	SMD2835	3000 K	GU10	120	25000	20	AC 95-265V	400	50x50	200
KE08422U	7W	SMD2835	3000 K	GU10	120	25000	20	AC 95-265V	560	50x50	200
KE08421GU	5W	SMD2835	GREEN	GU10	120	25000	20	AC 95-265V	400	50x50	200
KE08422GU	7W	SMD2835	GREEN	GU10	120	25000	20	AC 95-265V	560	50x50	200



## G45 LED LAMP

- \* Strong Day Light
- \* Long Service Life

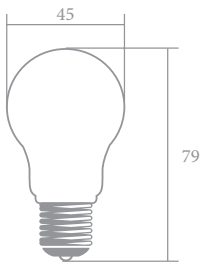

Day Light

**A+**

Energy Saving



Thermoplastic Body



Eco Friendly



3000K

4000K

6400K

P. Code	W	TypeLed	☀️	⊞	⌚	⌚	IP	V	lm	Size (mm)	🏠
KE15101	3W	SMD2835	6500 K	E27	270	25000	20	AC 100-265 V	250	45x80	100
KE15111	3W	SMD2835	4000 K	E27	270	25000	20	AC 100-265 V	250	45x80	100
KE15102	5W	SMD2835	6500 K	E27	270	25000	20	AC 100-265 V	400	45x80	100
KE15112	5W	SMD2835	4000 K	E27	270	25000	20	AC 100-265 V	400	45x80	100
KE15103	7W	SMD2835	6500 K	E27	270	25000	20	AC 100-265 V	650	45x80	100
KE15113	7W	SMD2835	4000 K	E27	270	25000	20	AC 100-265 V	650	45x80	100





# LED REFLECTOR LAMP

- Stylish Design ✨
- High Effective ✨
- Energy Conservation ✨

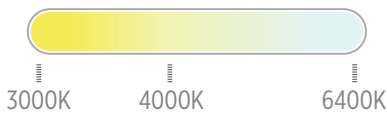

Day Light

**A+**

Energy Saving



Thermoplastic Body



Eco Friendly

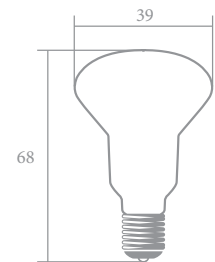

P. Code	W	TypeLed	☀️	⊞	⌚	🕒	IP	V	lm	Size (mm)	🏠
KE03103	6W	SMD2835	6500 K	E14	110	25000	20	AC 95-265V	540	50x88	100
KE03104	8W	SMD2835	6500 K	E27	110	25000	20	AC 95-265V	720	63x104	50
KE03105	10W	SMD2835	6500 K	E27	110	25000	20	AC 95-265V	900	80x112	50
KE03114	8W	SMD2835	4000 K	E27	110	25000	20	AC 95-265V	720	63x104	50
KE03115	10W	SMD2835	4000 K	E27	110	25000	20	AC 95-265V	900	80x112	50



## COLORED LED BULB

- \* High Efficiency
- \* Stylish & Decorative Bulb

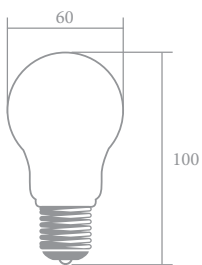

**A+**



Energy Saving

Thermoplastic Body

Eco Friendly

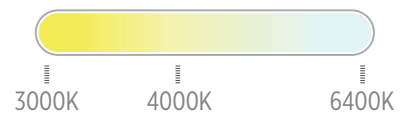

P. Code	W	TypeLed	★	Color	⊘	⌂	⌚	IP	V	lm	Size (mm)	⊞
KE48901	7W	SMD2835	6500K	Blue	E27	270	25000	20	AC 100-265V	450	60x100	100
KE48902	7W	SMD2835	6500K	Red	E27	270	25000	20	AC 100-265V	450	60x100	100
KE48903	7W	SMD2835	6500K	Green	E27	270	25000	20	AC 100-265V	450	60x100	100

**FLAME LED LAMP**



P. Code	W	TypeLed					IP	V	lm	Size (mm)	
KE48801F	6W	SMD2835	FLAME	E27	270	25000	20	AC 185-265 V	480	64x150	100

**FAN BLADE LED LAMP**



P. Code	W	TypeLed					IP	V	lm	Size (mm)	
KE48911	40W	SMD2835	6500K	E27	270	25000	20	AC 110-265 V	3600	360x170	100

**FOLDABLE BALL LED LAMP**

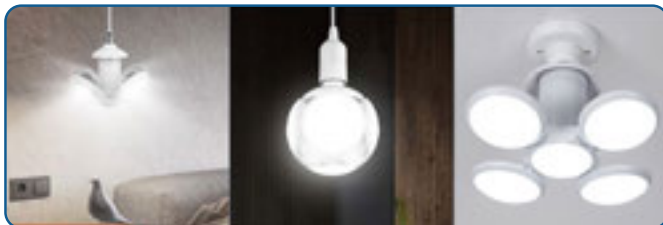

P. Code	W	TypeLed					IP	V	lm	Size (mm)	
KE48912	30W	SMD2835	6500K	E27	270	25000	20	AC 110-265 V	2700	240x125	100



# KLAUS®

[www.klauselectric.com](http://www.klauselectric.com)



**Led Candle Lamps**





## LED CANDLE LAMP

Strong Warm & Day Light ✨

High Illumination ✨

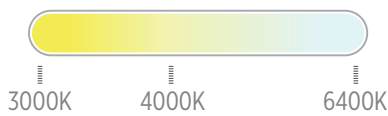

Day & Warm Light

**A+**

Energy Saving



Thermoplastic Body



Eco Friendly

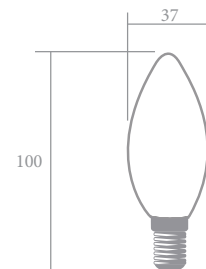

P. Code	W	TypeLed	☀️	⚡	🔄	🕒	IP	V	lm	Size (mm)	📦
KE49204	6W	SMD2835	6400 K	E14	270	35000	20	AC 100-260 V	480	37x100	100
KE49205	6W	SMD2835	3000 K	E14	270	35000	20	AC 100-260 V	480	37x100	100
KE49208	6W	SMD2835	4500 K	E14	270	35000	20	AC 100-260 V	480	37x100	100
KE49206	8W	SMD2835	6400 K	E14	270	35000	20	AC 100-260 V	640	37x100	100
KE49207	8W	SMD2835	3000 K	E14	270	35000	20	AC 100-260 V	640	37x100	100
KE49209	8W	SMD2835	4500 K	E14	270	35000	20	AC 100-260 V	640	37x100	100



## LED CANDLE LAMP

\* Strong Warm & Day Light

\* Low Power Consumption

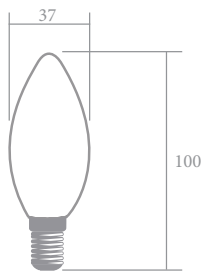

Day & Warm Light

**A+**

Energy Saving



Thermoplastic Body



Eco Friendly



3000K

4000K

6400K

P. Code	W	TypeLed	☀	☰	⏸	🕒	IP	V	lm	Size (mm)	📦
KE49224	6W	SMD2835	6400 K	E27	270	35000	20	AC 100-260 V	480	37x100	100
KE49225	6W	SMD2835	3000 K	E27	270	35000	20	AC 100-260 V	480	37x100	100
KE49228	6W	SMD2835	4500 K	E27	270	35000	20	AC 100-260 V	640	37x100	100
KE49226	8W	SMD2835	6400 K	E27	270	35000	20	AC 100-260 V	640	37x100	100
KE49227	8W	SMD2835	3000 K	E27	270	35000	20	AC 100-260 V	640	37x100	100
KE49229	8W	SMD2835	4500 K	E27	270	35000	20	AC 100-260 V	640	37x100	100



## LED CANDLE TAILED LAMP

Strong Warm & Day Light ✨

Stylish & Decorative ✨

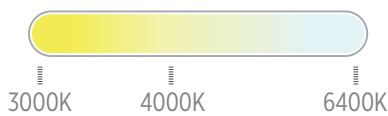

-   
Day & Warm  
Light
- A+**  
Energy  
Saving
-   
Thermoplastic  
Body
-   
Eco  
Friendly

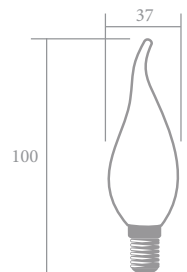

P. Code	W	TypeLed	☀️	🌀	🔌	🕒	IP	V	lm	Size (mm)	📏
KE49214	6W	SMD2835	6400 K	E14	270	35000	20	AC 100-260 V	480	37x100	100
KE49215	6W	SMD2835	3000 K	E14	270	35000	20	AC 100-260 V	480	37x100	100
KE49218	6W	SMD2835	4500 K	E14	270	35000	20	AC 100-260 V	640	37x100	100
KE49216	8W	SMD2835	6400 K	E14	270	35000	20	AC 100-260 V	640	37x100	100
KE49217	8W	SMD2835	3000 K	E14	270	35000	20	AC 100-260 V	640	37x100	100
KE49219	8W	SMD2835	4500 K	E14	270	35000	20	AC 100-260 V	640	37x100	100



## LED CANDLE TAILED LAMP

\* Strong Warm & Day Light

\* Long Life Span

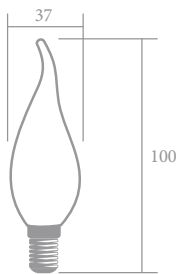

Day & Warm  
Light

**A+**

Energy  
Saving



Thermoplastic  
Body



Eco  
Friendly

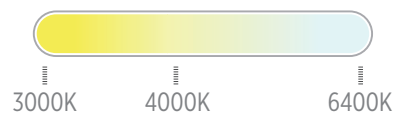

P. Code	W	TypeLed	☀	☰	⚡	🕒	IP	V	lm	Size (mm)	📏
KE49234	6W	SMD2835	6400 K	E27	270	35000	20	AC 100-260 V	480	Φ37*125	100
KE49235	6W	SMD2835	3000 K	E27	270	35000	20	AC 100-260 V	480	Φ37*125	100
KE49238	6W	SMD2835	4500 K	E27	270	35000	20	AC 100-260 V	640	Φ37*125	100
KE49236	8W	SMD2835	6400 K	E27	270	35000	20	AC 100-260 V	640	Φ37*125	100
KE49237	8W	SMD2835	3000 K	E27	270	35000	20	AC 100-260 V	640	Φ37*125	100
KE49239	8W	SMD2835	4500 K	E27	270	35000	20	AC 100-260 V	640	Φ37*125	100



# KLAUS®

[www.klauselectric.com](http://www.klauselectric.com)

Led Floodlights



**NEW**



## SMD LED FLOODLIGHT

- \* Long Life & Durable Alluminium Body
- \* High Efficiency
- \* Stylish Design

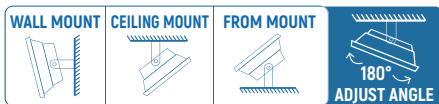

Day Light

**A+**

Energy Saving



Alluminium Body



Eco Friendly

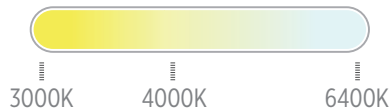

P. Code	W	TypeLed	☀	↻	🕒	IP	V	lm	Size (mm)	📏
KE09882	30W	SMD2835	6500K	120	30000	65	AC 100-265 V	3000	169,5x154x31,3	20
KE09883	50W	SMD2835	6500K	120	30000	65	AC 100-265 V	5000	205,3x182x31,7	20
KE09885	100W	SMD2835	6500K	120	30000	65	AC 100-265 V	10000	243,8x216x33	10
KE09886	150W	SMD2835	6500K	120	30000	65	AC 100-265 V	15000	277x249,4x33	10





## SMD LED FLOODLIGHT

- Long Life & Durable ✱  
Alluminium Body
- High Efficiency ✱
- Stylish Design ✱



Day & Warm Light

**A+**

Energy Saving



Alluminium Body



Eco Friendly

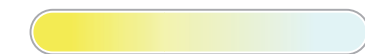

3000K 4000K 6400K

P. Code	W	TypeLed	☀	↻	🕒	IP	V	lm	Size (mm)	📏
KE09820	10W	SMD2835	6500K	120	30000	65	AC 220-240 V	800	70x43x92	60
KE09821	20W	SMD2835	6500K	120	30000	65	AC 220-240 V	1600	90x43x125	40
KE09822	30W	SMD2835	6500K	120	30000	65	AC 220-240 V	2400	110x43x160	20
KE09823	50W	SMD2835	6500K	120	30000	65	AC 220-240 V	4000	160x43x205	20
KE09824	100W	SMD2835	6500K	120	30000	65	AC 220-240 V	8000	210x43x270	8
KE09825	200W	SMD2835	6500K	120	30000	65	AC 220-240 V	16000	370x279xH46	4
KE09830	10W	SMD2835	3000K	120	30000	65	AC 220-240 V	800	70x43x92mm	60
KE09831	20W	SMD2835	3000K	120	30000	65	AC 220-240 V	1600	90x43x125mm	40
KE09832	30W	SMD2835	3000K	120	30000	65	AC 220-240 V	2400	110x43x160mm	20
KE09833	50W	SMD2835	3000K	120	30000	65	AC 220-240 V	4000	160x43x205mm	20
KE09834	100W	SMD2835	3000K	120	30000	65	AC 220-240 V	8000	210x43x270mm	8
KE09835	200W	SMD2835	3000K	120	30000	65	AC 220-240 V	16000	370x279xH46	4



## SMD LED FLOODLIGHT

- \* Long Life & Durable  
Alluminium Body
- \* High Efficiency
- \* Stylish Design

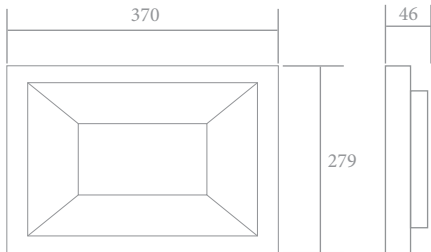

P. Code	W	TypeLed	☀	↻	🕒	IP	V	lm	Size (mm)	📦
KE09820B	10W	SMD2835	6500K	120	30000	65	AC 220-240 V	800	70x43x92	60
KE09821B	20W	SMD2835	6500K	120	30000	65	AC 220-240 V	1600	90x43x125	40
KE09822B	30W	SMD2835	6500K	120	30000	65	AC 220-240 V	2400	110x43x160	20
KE09823B	50W	SMD2835	6500K	120	30000	65	AC 220-240 V	4000	160x43x205	20
KE09824B	100W	SMD2835	6500K	120	30000	65	AC 220-240 V	8000	210x43x270	8
KE09825B	200W	SMD2835	6500K	120	30000	65	AC 220-240 V	16000	370x279xH46	4
KE09830B	10W	SMD2835	3000K	120	30000	65	AC 220-240 V	800	70x43x92mm	60
KE09831B	20W	SMD2835	3000K	120	30000	65	AC 220-240 V	1600	90x43x125mm	40
KE09832B	30W	SMD2835	3000K	120	30000	65	AC 220-240 V	2400	110x43x160mm	20
KE09833B	50W	SMD2835	3000K	120	30000	65	AC 220-240 V	4000	160x43x205mm	20
KE09834B	100W	SMD2835	3000K	120	30000	65	AC 220-240 V	8000	210x43x270mm	8
KE09835B	200W	SMD2835	3000K	120	30000	65	AC 220-240 V	16000	370x279xH46	4





## SMD ULTRASLIM LED FLOODLIGHT WITH SENSOR

- Long Life & Durable ✨
- Alluminium Body
- Ultra Slim Body ✨

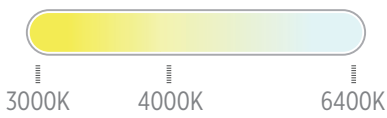

Day Light

**A+**

Energy Saving



Alluminium Body



Eco Friendly

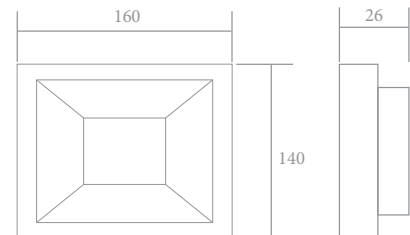

P. Code	W	TypeLed	☀️	⌂	🕒	IP	V	lm	Size (mm)	📦
KE09841S	20W	SMD2835	6500 K	120	30000	44	AC 85-265 V	1200	140*160*26	50
KE09842S	30W	SMD2835	6500 K	120	30000	44	AC 85-265 V	1800	170*190*28	40
KE09843S	50W	SMD2835	6500 K	120	30000	44	AC 85-265 V	3000	210*220*30	20
KE09844S	100W	SMD2835	6500 K	120	30000	44	AC 85-265 V	6000	280*280*370	20



# SMD ULTRASLIM LED FLOODLIGHT

- \* Long Life & Durable Alluminium Body
- \* Ultra Slim Body

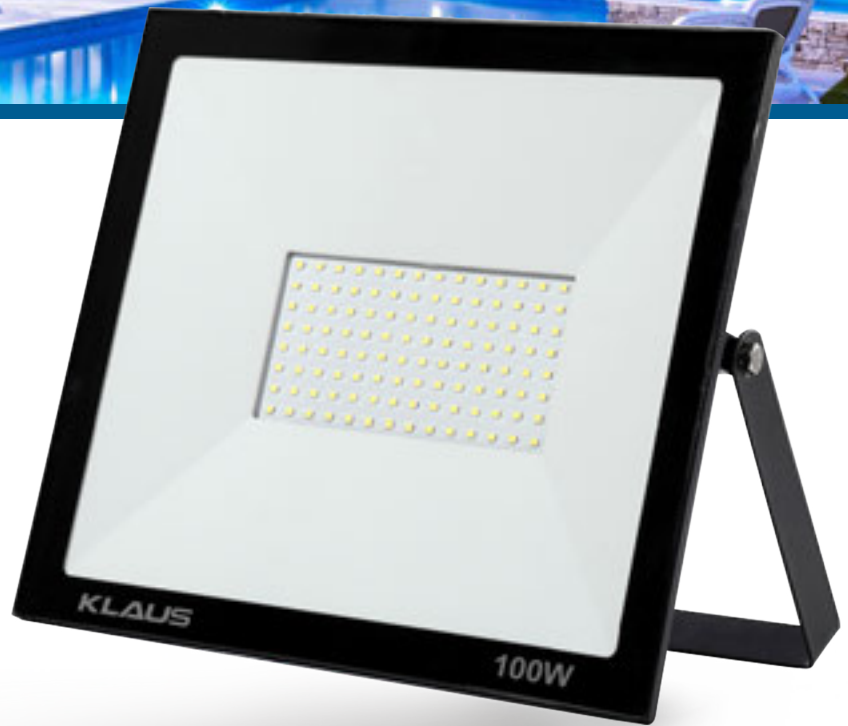

P. Code	W	TypeLed	☀	↻	🕒	IP	V	lm	Size (mm)	🔊
KE09841	20W	SMD2835	6500 K	120	30000	65	AC 85-265 V	1200	140x120x26	50
KE09842	30W	SMD2835	6500 K	120	30000	65	AC 85-265 V	1800	170x150x28	40
KE09843	50W	SMD2835	6500 K	120	30000	65	AC 85-265 V	3000	210x180x30	20
KE09844	100W	SMD2835	6500 K	120	30000	65	AC 85-265 V	6000	280x240x370	20
KE09845	150W	SMD2835	6500 K	120	30000	65	AC 85-265 V	9000	340x300x45	10
KE09846	200W	SMD2835	6500 K	120	30000	65	AC 85-265 V	12000	340x300x45	10





## MODULE LED FLOODLIGHT



- Long Life & Durable ✱
- Alluminium Body ✱
- Rotatable Modules ✱
- Constant Current IC Driver ✱



Day Light

**A+**

Energy Saving



Alluminium Body



Eco Friendly



3000K

4000K

6400K

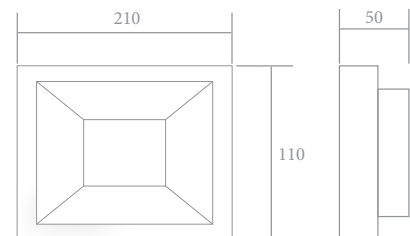

P. Code	W	TypeLed	☀	⌂	🕒	IP	V	lm	Size (mm)	🏠
KE09850	50W	COB Led	6500 K	120	30000	65	AC 85-265 V	4000	235x80x135	20
KE09851	100W	COB Led	6500 K	120	30000	65	AC 85-265 V	8000	235x95x220	8
KE09852	150W	COB Led	6500 K	120	30000	65	AC 85-265 V	12000	235x115x340	6



## SMD LED SLIM FLOODLIGHT

- \* Long Life & Durable Alluminium Body
- \* Waterproof
- \* Easy Installation
- \* Slim Body



Day Light

**A+**

Energy Saving



Alluminium Body



Eco Friendly

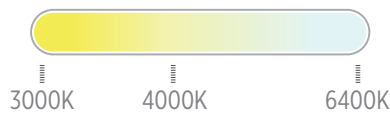

P. Code	W	TypeLed	☀️	🔊	🕒	IP	V	lm	Size (mm)	🏠
KE09801	10W	SMD5730	6500 K	120	30000	65	AC 85-265V	800	112x84x31	50
KE09802	20W	SMD5730	6500 K	120	30000	65	AC 85-265V	1600	138x179x38	30
KE09803	30W	SMD5730	6500 K	120	30000	65	AC 85-265V	2400	283x233x57	20
KE09804	50W	SMD5730	6500 K	120	30000	65	AC 85-265V	4000	332x283x66	10
KE09805	80W	SMD5730	6500 K	120	30000	65	AC 85-265V	6400	332x285x66	10
KE09806	100W	SMD5730	6500 K	120	30000	65	AC 85-265V	8000	332x285x66	5
KE09807	150W	SMD5730	6500 K	120	30000	65	AC 85-265V	12000	411x319x75	2
KE09808	200W	SMD5730	6500 K	120	30000	65	AC 85-265V	16000	411x319x104	2
KE09809	300W	SMD5730	6500 K	120	30000	65	AC 85-265V	24000	444x382x108	1
KE09810	400W	SMD5730	6500 K	120	30000	65	AC 85-265V	32000	486x415x111	1





## SMD LED FLOODLIGHT WITH TRIPOD

- Long Life & Durable ✨
- Alluminium Body
- Waterproof ✨

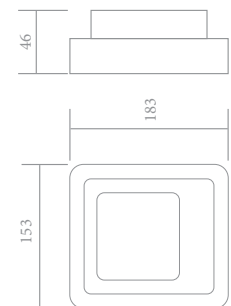

Day & Warm Light

A+

Energy Saving



Thermoplastic Body



Eco Friendly

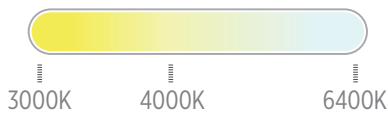

P. Code	W	TypeLed	☀️	🔄	🕒	IP	V	lm	Size (mm)	☔
KE09706	2x20W	SMD5730	6500 K	120	35000	65	AC 85-265 V	3200	153x183x46	15

P. Code	Height	Cable Length	Plug	Size (mm)	☔
KE09706T	2 mt.	2 mt.	European	2x0.74x0.74	6



## RECHARGEABLE LED FLOODLIGHT

- \* Lightweight Portable
- \* Rechargeable Battery
- \* Discharge Time: 3-4 Hours



Lithium Battery



Day Light

**A+**

Energy Saving



Alluminium Body



Eco Friendly

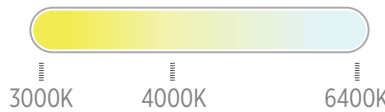

P. Code	W	TypeLed	☀️	⚡️	🕒	IP	V	lm	Size (mm)	☂️
KE09705	10W	SMD3030	6500 K	120	35000	54	AC 220-240 V	500	145x165x260	10
KE09707	20W	SMD3030	6500 K	120	35000	54	AC 220-240 V	1000	215x185x310	6



## RECHARGEABLE LED SLIM FLOODLIGHT

- Lightweight Portable ✱
- Rechargeable Battery ✱
- Discharge Time: 3-4 Hours ✱



Lithium Battery



Day Light

**A+**

Energy Saving



Alluminium Body



Eco Friendly



3000K

4000K

6400K



P. Code	W	TypeLed	☀	☼	🕒	IP	V	lm	Size (mm)	📦
KE09751	10W	SMD3030	6500 K	120	30000	65	AC 100-240 V	400	280x150x400	20
KE09752	20W	SMD3030	6500 K	120	30000	65	AC 100-240 V	800	330x220x430	20
KE09753	30W	SMD3030	6500 K	120	30000	65	AC 100-240 V	1200	380x220x500	10
KE09754	50W	SMD3030	6500 K	120	30000	65	AC 100-240 V	2000	430x310x630	6



# KLAUS<sup>®</sup>

[www.klauselectric.com](http://www.klauselectric.com)



**Led Street Lights**



**NEW**



## SMD LED STREET LIGHTS

- Long Life & Durable ✱  
Alluminium Body
- High Heat Efficiency ✱
- Modular Design ✱



**A+**



Day Light

Energy Saving

Alluminium Body

Eco Friendly

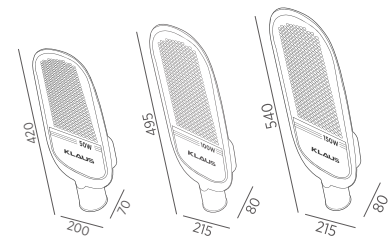
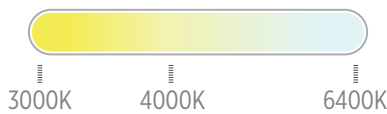

P. Code	W	TypeLed	☀️	⌂	🕒	IP	V	lm	Size (mm)	📦
KE56401	50W	SMD5730	6500 K	120	30000	65	AC 85-305 V	5500	420x200x70	1
KE56402	100W	SMD5730	6500 K	120	30000	65	AC 85-305 V	11000	495x215x80	1
KE56403	150W	SMD5730	6500 K	120	30000	65	AC 85-305 V	16500	540x215x80	1
KE56404	200W	SMD5730	6500 K	120	30000	65	AC 85-305 V	22000	600x235x80	1

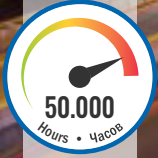

## COB LED STREET LIGHTS

- \* Long Life & Durable Alluminium Body
- \* High Heat Efficiency
- \* Modular Design

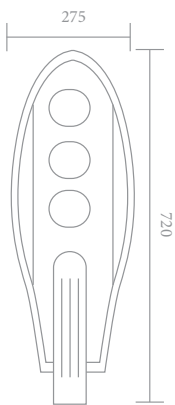

Day Light

**A+**

Energy Saving



Alluminium Body



Eco Friendly



3000K

4000K

6400K

P. Code	W	TypeLed	☀	☾	🕒	IP	V	lm	Size (mm)	☔
KE56202	50W	COB Led	6500 K	85°*135°	50000	65	AC 85-265 V	3500	500x210x65	1
KE56203	80W	COB Led	6500 K	85°*135°	50000	65	AC 85-265 V	5600	720x275x75	1
KE56204	100W	COB Led	6500 K	85°*135°	50000	65	AC 85-265 V	7000	720x275x75	1
KE56205	150W	COB Led	6500 K	85°*135°	50000	65	AC 85-265 V	10500	850x325x75	1



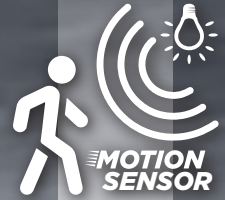

## SOLAR LED STREET LIGHTS

- Thermoplastic Body \*
- During Darkness; Keeps %20 Light \*
- When Radar Sensor Works; Keeps 100% Light \*



Solar Panel



Lithium Iron Phosphate Battery



Day Light

**A+**

Energy Saving



Alluminium Body



Eco Friendly

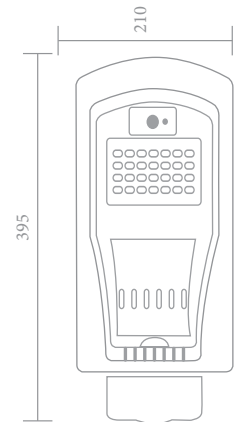
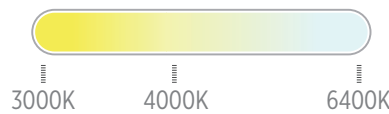

P. Code	W	TypeLed	☀️	⤵️	🕒	IP	V	lm	Size (mm)	📦
KE56301	20W	SMD2835	6500 K	90	50000	65	AC 85-265 V	1000	395x210x60	12
KE56302	40W	SMD2835	6500 K	90	50000	65	AC 85-265 V	2000	495x240x70	8
KE56303	60W	SMD2835	6500 K	90	50000	65	AC 85-265 V	3000	635x260x70	6
KE56304	80W	SMD2835	6500 K	90	50000	65	AC 85-265 V	4000	735x260x70	6

# KLAUS®

[www.klauselectric.com](http://www.klauselectric.com)



**Wall Lights**



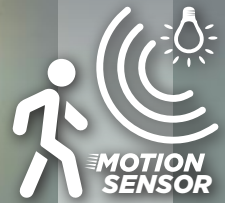

## LED WALL LIGHT WITH SENSOR

- Long Life & Durable ✨  
Alluminium Body
- High Heat Efficiency ✨
- Modular Design ✨



Day Light

**A+**

Energy Saving



Alluminium Body



Eco Friendly



3000K

4000K

6400K

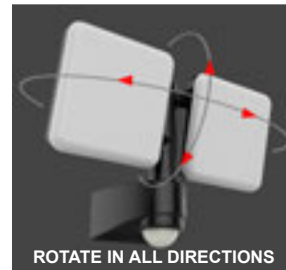

P. Code	W	TypeLed	☀️	◡	🕒	IP	V	lm	Size (mm)	📦
KE35771	10W	SMD2835	6500K	120	30000	54	AC 175-265 V	900	152x140x230	20
KE35772	20W	SMD2835	6500K	120	30000	54	AC 175-265 V	1800	134x330x230	10
<i>With Sensor</i>										
KE35773S	10W	SMD2835	6500K	120	30000	54	AC 175-265 V	800	140x65x167	20
KE35771S	10W	SMD2835	6500K	120	30000	54	AC 175-265 V	900	152x140x230	20
KE35772S	20W	SMD2835	6500K	120	30000	54	AC 175-265 V	1800	134x330x230	10



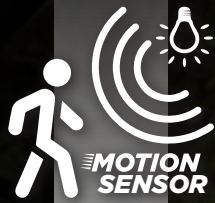

## SOLAR LED WALL LIGHT

- \* Long Life & Durable Alluminium Body
- \* High Heat Efficiency
- \* Modular Design

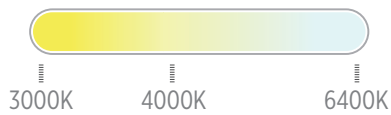

Day Light

**A+**

Energy Saving



Alluminium Body



Eco Friendly



Full Light: **4 Hours**  
Night Light: **60 Hours (%5 Power)**



Lithium Battery

P. Code	W	TypeLed	☀️	🔊	🕒	IP	V	Size (mm)	🔋
KE35752	2W	SMD2835	6500	110	30000	54	3.7V 1200 mah	96x124x48	50
KE35754	2W	SMD2835	6500	110	30000	54	3.7V 1500 mah	171x114x42	50

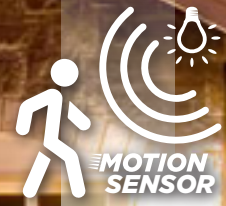

## LED WALL SPOTLIGHT WITH SENSOR

- Long Life & Durable ✦  
Alluminium Body
- High Heat Efficiency ✦
- Modular Design ✦



Day Light

**A+**

Energy Saving



Alluminium Body



Eco Friendly



3000K

4000K

6400K

P. Code	W	TypeLed	★	⌂	🕒	IP	V	lm	Size (mm)	🔌
KE35761S	10W	COB Led	6500	90	40000	54	AC 175-265 V	900	231x113x178	10
KE35762S	20W	COB Led	6500	90	40000	54	AC 175-265 V	900	240x168x181	10



# KLAUS®

[www.klauselectric.com](http://www.klauselectric.com)



**Led Tubes,  
Fixtures, Panel Lights**



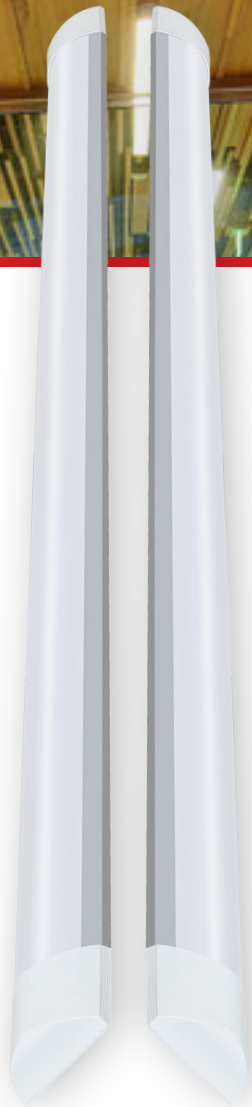

## LED FIXTURES

- Alluminium & Plastic Body \*
- High Lumen Efficiency \*
- Low Power Consumption \*

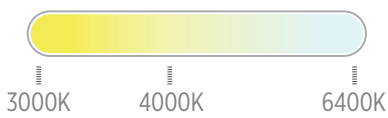

Day  
Light

**A+**

Energy  
Saving



Eco  
Friendly



P. Code	W	TypeLed				IP	V	lm	Size (mm)	
KE53102	20W	COB	6500K	120	30000	20	AC 170-265 V	1800	600	20
KE53103	30W	COB	6500K	120	30000	20	AC 170-265 V	2700	900	30
KE53112	40W	COB	6500K	120	30000	20	AC 170-265 V	3600	1200	20
KE53104	60W	COB	6500K	120	30000	20	AC 170-265 V	5400	1200	30
KE53105	80W	COB	6500K	120	30000	20	AC 170-265 V	7200	1200	30



## LED GLASS TUBES

- \* No Warping - Bending
- \* Better Luminance

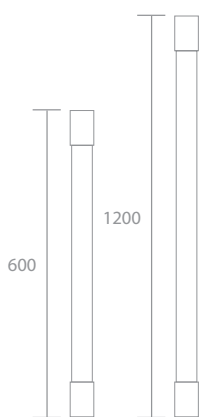

Day Light

**A+**

Energy Saving



Glass Tube



Eco Friendly

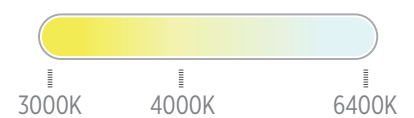

P. Code	W	TypeLed	☀️	⌚	⌚	IP	V	lm	Size (mm)	📏
KE07601	9W	SMD2835	6500K	360	10000	20	AC 170-260 V	750	1200	30
KE07602	18W	SMD2835	6500K	360	10000	20	AC 170-260 V	1550	600	30
KE07701	9W	SMD2835	6500K	360	10000	20	AC 170-260 V	750	1200	28
KE07702	18W	SMD2835	6500K	360	10000	20	AC 170-260 V	1550	600	28

**NEW**



## FRAMELESS RECESSED LED PANEL

Alluminium & Plastic Body \*

High Lumen Efficiency \*

Adjustable Hole Size \*



Day  
Light

**A+**

Energy  
Saving



Eco  
Friendly

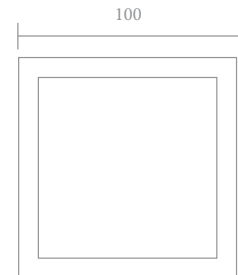
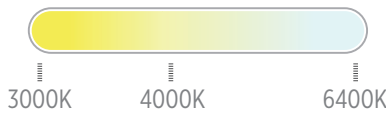

P. Code	W	TypeLed	Frame				IP	V	lm	Size (mm)	
KE35962	12W	SMD2835	Square	4500K	120	50000	20	AC 100-265 V	1080	100x100	100
KE35963	18W	SMD2835	Square	6500K	120	50000	20	AC 100-265 V	1620	120x120	60
KE35964	24W	SMD2835	Square	4500K	120	50000	20	AC 100-265 V	2160	170x170	40
KE35965	35W	SMD2835	Square	6500K	120	50000	20	AC 100-265 V	3150	225x225	30
KE35972	12W	SMD2835	Square	6500K	120	50000	20	AC 100-265 V	1080	100x100	100
KE35973	18W	SMD2835	Square	4500K	120	50000	20	AC 100-265 V	1620	120x120	60
KE35974	24W	SMD2835	Square	6500K	120	50000	20	AC 100-265 V	2160	170x170	40
KE35975	35W	SMD2835	Square	4500K	120	50000	20	AC 100-265 V	3150	225x225	30
KE35982	12W	SMD2835	Square	4500K	120	50000	20	AC 100-265 V	1080	100x100	100
KE35983	18W	SMD2835	Square	6500K	120	50000	20	AC 100-265 V	1620	120x120	60
KE35984	24W	SMD2835	Square	4500K	120	50000	20	AC 100-265 V	2160	170x170	40
KE35985	35W	SMD2835	Square	6500K	120	50000	20	AC 100-265 V	3150	225x225	30



**NEW**



## FRAMELESS RECESSED LED PANEL

- \* Aluminium & Plastic Body
- \* High Lumen Efficiency
- \* Adjustable Hole Size

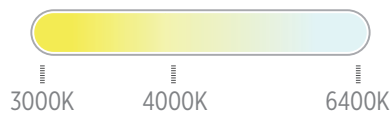
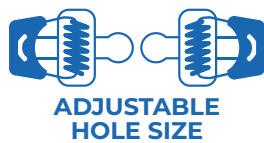
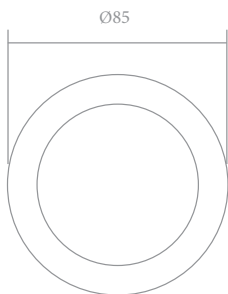

Day Light

**A+**

Energy Saving



Eco Friendly

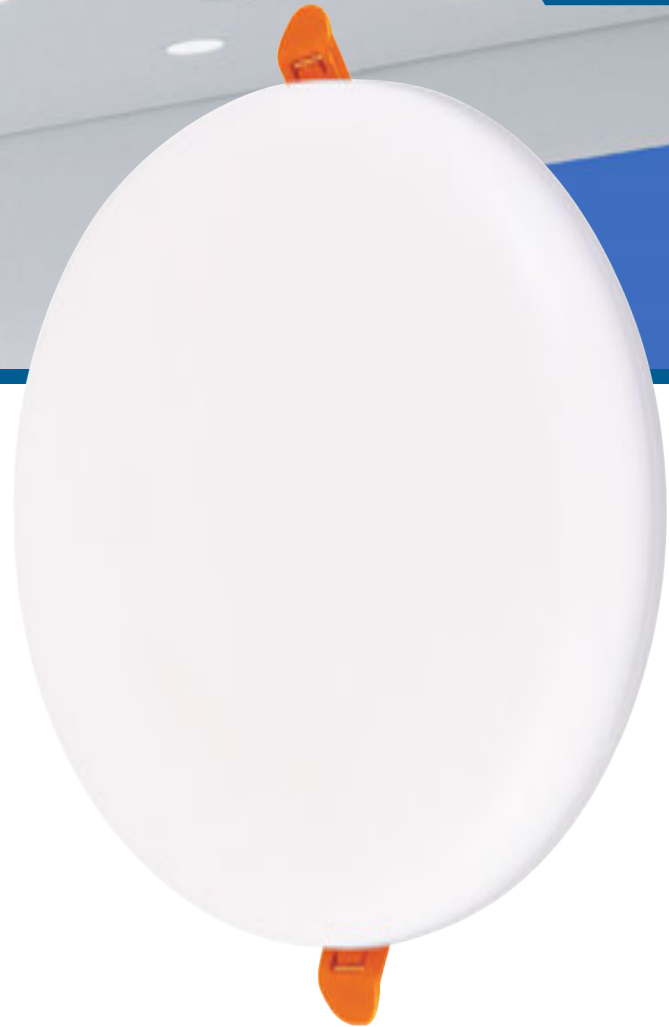

P. Code	W	TypeLed	Frame				IP	V	lm	Size (mm)	
KE35931	9W	SMD2835	Round	6500K	120	50000	20	AC 100-265 V	810	85x85	-
KE35932	12W	SMD2835	Round	6500K	120	50000	20	AC 100-265 V	1080	100x100	100
KE35933	18W	SMD2835	Round	6500K	120	50000	20	AC 100-265 V	1620	120x120	60
KE35934	24W	SMD2835	Round	6500K	120	50000	20	AC 100-265 V	2160	170x170	40
KE35935	35W	SMD2835	Round	6500K	120	50000	20	AC 100-265 V	3150	225x225	30
KE35941	9W	SMD2835	Round	4000K	120	50000	20	AC 100-265 V	810	85x85	-
KE35942	12W	SMD2835	Round	4000K	120	50000	20	AC 100-265 V	1080	100x100	100
KE35943	18W	SMD2835	Round	4000K	120	50000	20	AC 100-265 V	1620	120x120	60
KE35944	24W	SMD2835	Round	4000K	120	50000	20	AC 100-265 V	2160	170x170	40
KE35945	35W	SMD2835	Round	4000K	120	50000	20	AC 100-265 V	3150	225x225	30
KE35951	9W	SMD2835	Round	4500K	120	50000	20	AC 100-265 V	810	85x85	-
KE35952	12W	SMD2835	Round	6500K	120	50000	20	AC 100-265 V	1080	100x100	100
KE35953	18W	SMD2835	Round	4500K	120	50000	20	AC 100-265 V	1620	120x120	60
KE35954	24W	SMD2835	Round	6500K	120	50000	20	AC 100-265 V	2160	170x170	40
KE35955	35W	SMD2835	Round	4500K	120	50000	20	AC 100-265 V	3150	225x225	30

**NEW**



## FRAMELESS SURFACED LED PANEL

Alluminium & Plastic Body \*

High Lumen Efficiency \*



Day Light

**A+**

Energy Saving



Eco Friendly

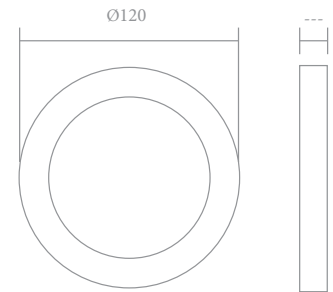
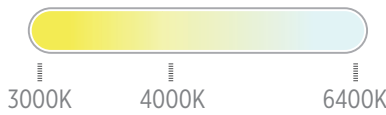

P. Code	W	TypeLed	Frame				IP	V	lm	Size (mm)	
KE35936	18W	SMD2835	Round	6500K	120	50000	20	AC 100-265 V	1620	120x120	60
KE35937	24W	SMD2835	Round	6500K	120	50000	20	AC 100-265 V	2160	170x170	40
KE35938	35W	SMD2835	Round	6500K	120	50000	20	AC 100-265 V	3150	225x225	30
KE35946	18W	SMD2835	Round	4000K	120	50000	20	AC 100-265 V	1620	120x120	60
KE35947	24W	SMD2835	Round	4000K	120	50000	20	AC 100-265 V	2160	170x170	40
KE35948	35W	SMD2835	Round	4000K	120	50000	20	AC 100-265 V	3150	225x225	30
KE35956	18W	SMD2835	Round	3000K	120	50000	20	AC 100-265 V	1620	120x120	60
KE35957	24W	SMD2835	Round	3000K	120	50000	20	AC 100-265 V	2160	170x170	40
KE35958	35W	SMD2835	Round	3000K	120	50000	20	AC 100-265 V	3150	225x225	30

**NEW**



## FRAMELESS SURFACED LED PANEL

- \* Aluminium & Plastic Body
- \* High Lumen Efficiency

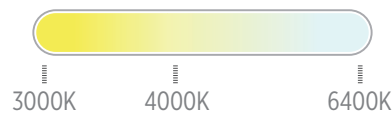
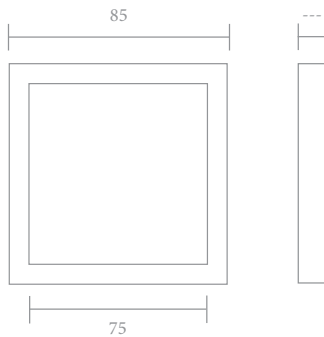

Day Light

**A+**

Energy Saving



Eco Friendly

P. Code	W	TypeLed	Frame				IP	V	lm	Size (mm)	
KE35966	18W	SMD2835	Square	6500K	120	50000	20	AC 100-265 V	1620	120x120	60
KE35967	24W	SMD2835	Square	6500K	120	50000	20	AC 100-265 V	2160	170x170	40
KE35968	35W	SMD2835	Square	6500K	120	50000	20	AC 100-265 V	3150	225x225	30
KE35976	18W	SMD2835	Square	4000K	120	50000	20	AC 100-265 V	1620	120x120	60
KE35977	24W	SMD2835	Square	4000K	120	50000	20	AC 100-265 V	2160	170x170	40
KE35978	35W	SMD2835	Square	4000K	120	50000	20	AC 100-265 V	3150	225x225	30
KE35986	18W	SMD2835	Square	3000K	120	50000	20	AC 100-265 V	1620	120x120	60
KE35987	24W	SMD2835	Square	3000K	120	50000	20	AC 100-265 V	2160	170x170	40
KE35988	35W	SMD2835	Square	3000K	120	50000	20	AC 100-265 V	3150	225x225	30





## ROUND LED PANEL LIGHT RECESSED

Long Life & Durable ✱  
Alluminium Body

High Efficiency ✱

Shockproof ✱



Day & Warm  
Light

**A+**

Energy  
Saving



Aluminium  
Frame



Eco  
Friendly

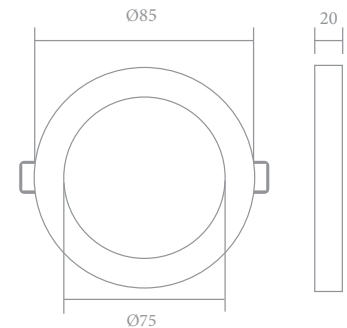
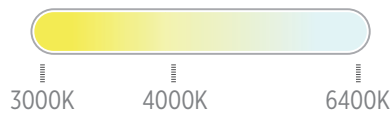

P. Code	W	TypeLed	Frame				IP	V	lm	Size (mm)	
KE35401K	3W	SMD2835	Round	6500K	120	50000	20	AC 85-265 V	210	85x75x20	100
KE35411K	3W	SMD2835	Round	4500K	120	50000	20	AC 85-265 V	210	85x75x20	100
KE35402K	6W	SMD2835	Round	6500K	120	50000	20	AC 85-265 V	420	120x110x20	100
KE35412K	6W	SMD2835	Round	4500K	120	50000	20	AC 85-265 V	420	120x110x20	100
KE35403K	9W	SMD2835	Round	6500K	120	50000	20	AC 85-265 V	630	150x135x20	40
KE35413K	9W	SMD2835	Round	4500K	120	50000	20	AC 85-265 V	630	150x135x20	40
KE35406K	12W	SMD2835	Round	6500K	120	50000	20	AC 85-265 V	840	170x155x20	30
KE35416K	12W	SMD2835	Round	4500K	120	50000	20	AC 85-265 V	840	170x155x20	30
KE35404K	15W	SMD2835	Round	6500K	120	50000	20	AC 85-265 V	1050	190x175x20	30
KE35414K	15W	SMD2835	Round	4500K	120	50000	20	AC 85-265 V	1050	190x175x20	30
KE35405K	18W	SMD2835	Round	6500K	120	50000	20	AC 85-265 V	1260	225x205x20	20
KE35415K	18W	SMD2835	Round	4500K	120	50000	20	AC 85-265 V	1260	225x205x20	20
KE35407K	24W	SMD2835	Round	6500K	120	50000	20	AC 85-265 V	1680	300x285x20	20
KE35417K	24W	SMD2835	Round	4500K	120	50000	20	AC 85-265 V	1680	300x285x20	20



## SQUARE LED PANEL LIGHT RECESSED

- \* Long Life & Durable Alluminium Body
- \* High Efficiency
- \* Shockproof

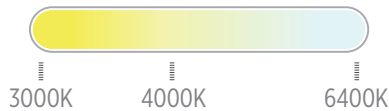
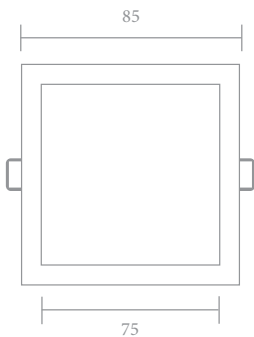

Day & Warm Light

**A+**

Energy Saving



Aluminium Frame



Eco Friendly



P. Code	W	TypeLed	Frame				IP	V	lm	Size (mm)	
KE35601K	3W	SMD2835	Square	6500K	120	50000	20	AC 85-265 V	210	85x75x20	100
KE35611K	3W	SMD2835	Square	4500K	120	50000	20	AC 85-265 V	210	85x75x20	100
KE35602K	6W	SMD2835	Square	6500K	120	50000	20	AC 85-265 V	420	120x110x20	100
KE35612K	6W	SMD2835	Square	4500K	120	50000	20	AC 85-265 V	420	120x110x20	100
KE35603K	9W	SMD2835	Square	6500K	120	50000	20	AC 85-265 V	630	150x135x20	40
KE35613K	9W	SMD2835	Square	4500K	120	50000	20	AC 85-265 V	630	150x135x20	40
KE35604K	12W	SMD2835	Square	6500K	120	50000	20	AC 85-265 V	840	170x155x20	30
KE35614K	12W	SMD2835	Square	4500K	120	50000	20	AC 85-265 V	840	170x155x20	30
KE35605K	15W	SMD2835	Square	6500K	120	50000	20	AC 85-265 V	1050	190x175x20	30
KE35615K	15W	SMD2835	Square	4500K	120	50000	20	AC 85-265 V	1050	190x175x20	30
KE35606K	18W	SMD2835	Square	6500K	120	50000	20	AC 85-265 V	1260	225x205x20	20
KE35616K	18W	SMD2835	Square	4500K	120	50000	20	AC 85-265 V	1260	225x205x20	20
KE35607K	24W	SMD2835	Square	6500K	120	50000	20	AC 85-265 V	1680	300x285x20	20
KE35617K	24W	SMD2835	Square	4500K	120	50000	20	AC 85-265 V	1680	300x285x20	20



## ROUND LED PANEL LIGHT SURFACED

- Long Life & Durable Body \*
- High Efficiency \*
- Shockproof \*



Day & Warm  
Light

**A+**

Energy  
Saving



Aluminium  
Frame



Eco  
Friendly

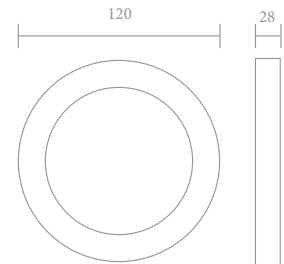
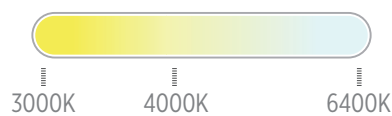

P. Code	W	Frame	TypeLed	Beam	Beam	⌚	IP	V	lm	Size (mm)	⚡
KE35910	6W	Round	SMD2835	6500K	120	50000	20	AC 85-265 V	480	120x28	100
KE35911	6W	Round	SMD2835	4500K	120	50000	20	AC 85-265 V	480	120x28	100
KE35903	12W	Round	SMD2835	6500K	120	50000	20	AC 85-265 V	960	170x28	40
KE35913	12W	Round	SMD2835	4500K	120	50000	20	AC 85-265 V	960	170x28	40
KE35305	18W	Round	SMD2835	6500K	120	50000	20	AC 85-265 V	1450	225x28	30
KE35315	18W	Round	SMD2835	4500K	120	50000	20	AC 85-265 V	1450	225x28	30
KE35307	24W	Round	SMD2835	6500K	120	50000	20	AC 85-265 V	1920	300x28	20
KE35317	24W	Round	SMD2835	4500K	120	50000	20	AC 85-265 V	1920	300x28	20
KE35703	30W	Round	SMD2835	6500K	120	50000	20	AC 85-265 V	2550	300x28	20
KE35713	30W	Round	SMD2835	4500K	120	50000	20	AC 85-265 V	2550	300x28	20





## SQUARE LED PANEL LIGHT SURFACED

- \* Long Life & Durable Body
- \* High Efficiency
- \* Shockproof

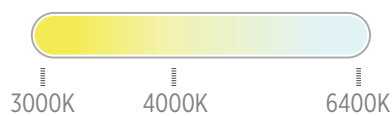
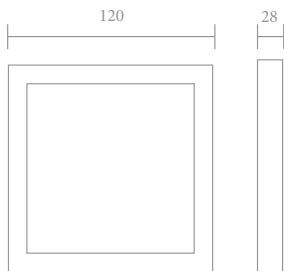

Day & Warm Light

**A+**

Energy Saving



Aluminium Frame



Eco Friendly

P. Code	W	Frame	TypeLed				IP	V	lm	Size (mm)	
KE35902	6W	Square	SMD2835	6500K	120	50000	20	AC 85-265 V	480	120x28	100
KE35912	6W	Square	SMD2835	4500K	120	50000	20	AC 85-265 V	480	120x28	100
KE35904	12W	Square	SMD2835	6500K	120	50000	20	AC 85-265 V	960	170x28	40
KE35914	12W	Square	SMD2835	4500K	120	50000	20	AC 85-265 V	960	170x28	40
KE35306	18W	Square	SMD2835	6500K	120	50000	20	AC 85-265 V	1450	225x28	30
KE35316	18W	Square	SMD2835	4500K	120	50000	20	AC 85-265 V	1450	225x28	30
KE35308	24W	Square	SMD2835	6500K	120	50000	20	AC 85-265 V	1920	300x28	20
KE35318	24W	Square	SMD2835	4500K	120	50000	20	AC 85-265 V	1920	300x28	20
KE35704	30W	Square	SMD2835	6500K	120	50000	20	AC 85-265 V	2550	300x28	20
KE35714	30W	Square	SMD2835	4500K	120	50000	20	AC 85-265 V	2550	300x28	20

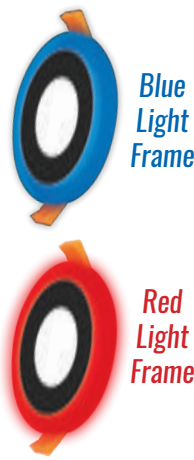

## ROUND LED PANEL LIGHT SURFACED

- Long Life & Durable Body \*
- Modern Design \*
- Colored Frame \*



Day & Warm Light

**A+**

Energy Saving



Aluminium Frame



Eco Friendly

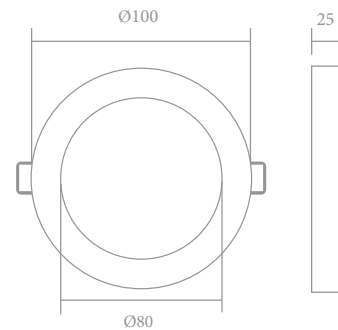
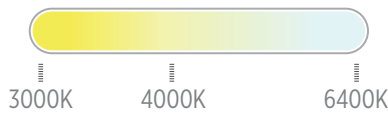

P. Code	W	Frame Color	TypeLed	☀	↻	🕒	IP	V	lm	Size (mm)	🔌
KE35801	3+3W	Blue Light	SMD2835	6500K	120	50000	20	AC 85-265 V	130	100x80x25	60
KE35811	3+3W	Blue Light	SMD2835	4500K	120	50000	20	AC 85-265 V	130	100x80x25	60
KE35802	6+3W	Blue Light	SMD2835	6500K	120	50000	20	AC 85-265 V	330	140x100x25	40
KE35812	6+3W	Blue Light	SMD2835	4500K	120	50000	20	AC 85-265 V	330	140x100x25	40
KE35803	12+4W	Blue Light	SMD2835	6500K	120	50000	20	AC 85-265 V	840	190x160x25	20
KE35813	12+4W	Blue Light	SMD2835	4500K	120	50000	20	AC 85-265 V	840	190x160x25	20
KE35804	18+6W	Blue Light	SMD2835	6500K	120	50000	20	AC 85-265 V	1250	240x210x25	20
KE35814	18+6W	Blue Light	SMD2835	4500K	120	50000	20	AC 85-265 V	1250	240x210x25	20
KE35801R	3+3W	Red Light	SMD2835	6500K	120	50000	20	AC 85-265 V	130	100x80x25	60
KE35811R	3+3W	Red Light	SMD2835	4500K	120	50000	20	AC 85-265 V	130	100x80x25	60
KE35802R	6+3W	Red Light	SMD2835	6500K	120	50000	20	AC 85-265 V	330	140x100x25	40
KE35812R	6+3W	Red Light	SMD2835	4500K	120	50000	20	AC 85-265 V	330	140x100x25	40
KE35803R	12+4W	Red Light	SMD2835	6500K	120	50000	20	AC 85-265 V	840	190x160x25	20
KE35813R	12+4W	Red Light	SMD2835	4500K	120	50000	20	AC 85-265 V	840	190x160x25	20
KE35804R	18+6W	Red Light	SMD2835	6500K	120	50000	20	AC 85-265 V	1250	240x210x25	20
KE35814R	18+6W	Red Light	SMD2835	4500K	120	50000	20	AC 85-265 V	1250	240x210x25	20



## SQUARE LED PANEL LIGHT SURFACED

- \* Long Life & Durable Body
- \* Modern Design
- \* Colored Frame

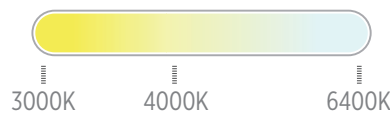
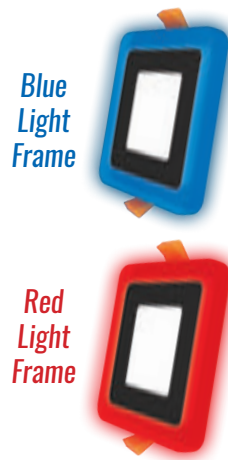
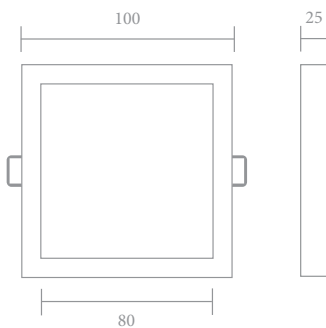

Day & Warm Light

**A+**

Energy Saving



Aluminium Frame



Eco Friendly

P. Code	W	Frame Color	TypeLed	☀	↻	🕒	IP	V	lm	Size (mm)	📏
KE35805	3+3W	Blue Light	SMD2835	6500K	120	50000	20	AC 85-265 V	130	100x80x25	60
KE35815	3+3W	Blue Light	SMD2835	4500K	120	50000	20	AC 85-265 V	130	100x80x25	60
KE35806	6+3W	Blue Light	SMD2835	6500K	120	50000	20	AC 85-265 V	330	140x100x25	40
KE35816	6+3W	Blue Light	SMD2835	4500K	120	50000	20	AC 85-265 V	330	140x100x25	40
KE35807	12+4W	Blue Light	SMD2835	6500K	120	50000	20	AC 85-265 V	840	190x160x25	20
KE35817	12+4W	Blue Light	SMD2835	4500K	120	50000	20	AC 85-265 V	840	190x160x25	20
KE35808	18+6W	Blue Light	SMD2835	6500K	120	50000	20	AC 85-265 V	1250	240x210x25	20
KE35818	18+6W	Blue Light	SMD2835	4500K	120	50000	20	AC 85-265 V	1250	240x210x25	20
KE35805R	3+3W	Red Light	SMD2835	6500K	120	50000	20	AC 85-265 V	130	100x80x25	60
KE35815R	3+3W	Red Light	SMD2835	4500K	120	50000	20	AC 85-265 V	130	100x80x25	60
KE35806R	6+3W	Red Light	SMD2835	6500K	120	50000	20	AC 85-265 V	330	140x100x25	40
KE35816R	6+3W	Red Light	SMD2835	4500K	120	50000	20	AC 85-265 V	330	140x100x25	40
KE35807R	12+4W	Red Light	SMD2835	6500K	120	50000	20	AC 85-265 V	840	190x160x25	20
KE35817R	12+4W	Red Light	SMD2835	4500K	120	50000	20	AC 85-265 V	840	190x160x25	20
KE35808R	18+6W	Red Light	SMD2835	6500K	120	50000	20	AC 85-265 V	1250	240x210x25	20
KE35818R	18+6W	Red Light	SMD2835	4500K	120	50000	20	AC 85-265 V	1250	240x210x25	20





Blue Light Frame



Red Light Frame

## ROUND LED PANEL LIGHT SURFACED

Long Life & Durable Body \*

Aluminium Alloy Frame \*

Provides Energy Saving \*



Day & Warm Light

A+

Energy Saving



Aluminium Frame



Eco Friendly

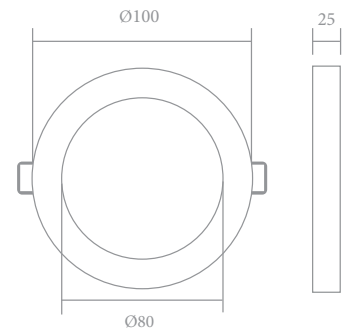
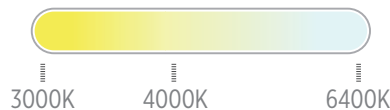

P. Code	W	Frame Color	TypeLed	☀	↻	🕒	IP	V	lm	Size (mm)	📏
KE36801	3+3W	Blue Light	SMD2835	6500K	120	50000	20	AC 85-265 V	130	100x80x25	60
KE36811	3+3W	Blue Light	SMD2835	4500K	120	50000	20	AC 85-265 V	130	100x80x25	60
KE36802	6+3W	Blue Light	SMD2835	6500K	120	50000	20	AC 85-265 V	330	140x100x25	40
KE36812	6+3W	Blue Light	SMD2835	4500K	120	50000	20	AC 85-265 V	330	140x100x25	40
KE36803	12+4W	Blue Light	SMD2835	6500K	120	50000	20	AC 85-265 V	840	190x160x25	20
KE36813	12+4W	Blue Light	SMD2835	4500K	120	50000	20	AC 85-265 V	840	190x160x25	20
KE36804	18+6W	Blue Light	SMD2835	6500K	120	50000	20	AC 85-265 V	1250	240x210x25	20
KE36814	18+6W	Blue Light	SMD2835	4500K	120	50000	20	AC 85-265 V	1250	240x210x25	20
KE36801R	3+3W	Red Light	SMD2835	6500K	120	50000	20	AC 85-265 V	130	100x80x25	60
KE36811R	3+3W	Red Light	SMD2835	4500K	120	50000	20	AC 85-265 V	130	100x80x25	60
KE36802R	6+3W	Red Light	SMD2835	6500K	120	50000	20	AC 85-265 V	330	140x100x25	40
KE36812R	6+3W	Red Light	SMD2835	4500K	120	50000	20	AC 85-265 V	330	140x100x25	40
KE36803R	12+4W	Red Light	SMD2835	6500K	120	50000	20	AC 85-265 V	840	190x160x25	20
KE36813R	12+4W	Red Light	SMD2835	4500K	120	50000	20	AC 85-265 V	840	190x160x25	20
KE36804R	18+6W	Red Light	SMD2835	6500K	120	50000	20	AC 85-265 V	1250	240x210x25	20
KE36814R	18+6W	Red Light	SMD2835	4500K	120	50000	20	AC 85-265 V	1250	240x210x25	20



## SQUARE LED PANEL LIGHT SURFACED

- \* Long Life & Durable Body
- \* Shockproof
- \* Colored Frame

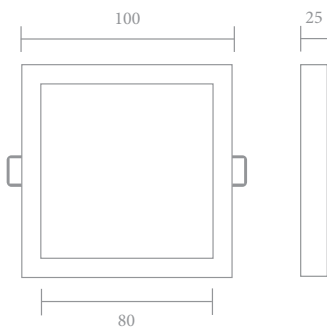

Blue Light Frame



Red Light Frame

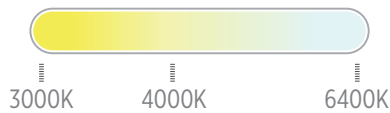

Day & Warm Light

**A+**

Energy Saving



Aluminium Frame



Eco Friendly

P. Code	W	Frame Color	TypeLed	☀	🔊	🕒	IP	V	lm	Size (mm)	📦
KE36805	3+3W	Blue Light	SMD2835	6500K	120	50000	20	AC 85-265 V	130	100x80x25	60
KE36815	3+3W	Blue Light	SMD2835	4500K	120	50000	20	AC 85-265 V	130	100x80x25	60
KE36806	6+3W	Blue Light	SMD2835	6500K	120	50000	20	AC 85-265 V	330	140x100x25	40
KE36816	6+3W	Blue Light	SMD2835	4500K	120	50000	20	AC 85-265 V	330	140x100x25	40
KE36807	12+4W	Blue Light	SMD2835	6500K	120	50000	20	AC 85-265 V	840	190x160x25	20
KE36817	12+4W	Blue Light	SMD2835	4500K	120	50000	20	AC 85-265 V	840	190x160x25	20
KE36808	18+6W	Blue Light	SMD2835	6500K	120	50000	20	AC 85-265 V	1250	240x210x25	20
KE36818	18+6W	Blue Light	SMD2835	4500K	120	50000	20	AC 85-265 V	1250	240x210x25	20
KE36805R	3+3W	Red Light	SMD2835	6500K	120	50000	20	AC 85-265 V	130	100x80x25	60
KE36815R	3+3W	Red Light	SMD2835	4500K	120	50000	20	AC 85-265 V	130	100x80x25	60
KE36806R	6+3W	Red Light	SMD2835	6500K	120	50000	20	AC 85-265 V	330	140x100x25	40
KE36816R	6+3W	Red Light	SMD2835	4500K	120	50000	20	AC 85-265 V	330	140x100x25	40
KE36807R	12+4W	Red Light	SMD2835	6500K	120	50000	20	AC 85-265 V	840	190x160x25	20
KE36817R	12+4W	Red Light	SMD2835	4500K	120	50000	20	AC 85-265 V	840	190x160x25	20
KE36808R	18+6W	Red Light	SMD2835	6500K	120	50000	20	AC 85-265 V	1250	240x210x25	20
KE36818R	18+6W	Red Light	SMD2835	4500K	120	50000	20	AC 85-265 V	1250	240x210x25	20



## SQUARE LED PANEL LIGHT RECESSED

Long Service Body \*

Unique Design \*



Day & Warm Light

**A+**

Energy Saving



Aluminium Frame



Eco Friendly

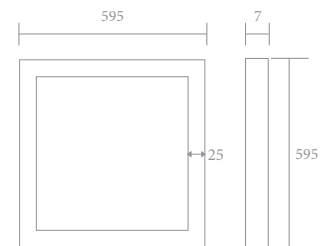
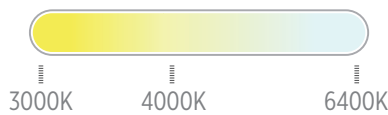

P. Code	W	TypeLed				IP	V	lm	Size (mm)	
KE35520	40W	SMD4014	6500 K	120	30000	20	AC 85-265 V	3600	595x595	10
KE35521	40W	SMD4014	4500 K	120	30000	20	AC 85-265 V	3600	595x595	10
KE35522	40W	SMD4014	3000 K	120	30000	20	AC 85-265 V	3600	595x595	10
KE35501	48W	SMD4014	6500 K	120	30000	20	AC 85-265 V	4320	595x595	10
KE35502	48W	SMD4014	4500 K	120	30000	20	AC 85-265 V	4320	595x595	10
KE35503	48W	SMD4014	3000 K	120	30000	20	AC 85-265 V	4320	595x595	10
KE35550	72W	SMD4014	6500 K	120	30000	20	AC 85-265 V	6480	595x595	10
KE35551	72W	SMD4014	4500 K	120	30000	20	AC 85-265 V	6480	595x595	10
KE35552	72W	SMD4014	3000 K	120	30000	20	AC 85-265 V	6480	595x595	10
KE35553	96W	SMD4014	6500 K	120	30000	20	AC 85-265 V	8640	595x595	10
KE35554	96W	SMD4014	4500 K	120	30000	20	AC 85-265 V	8640	595x595	10
KE35555	96W	SMD4014	3000 K	120	30000	20	AC 85-265 V	8640	595x595	10

### FRAMES

P. Code	Features	IP	Size (mm)	
KE35520	Plastic Surface Frame	20	600x600	25
KE35521	Aluminium Surface Frame	20	600x600	25



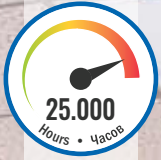

## SQUARE LED PANEL BACK LIGHT RECESSED

- \* Better Lumen Efficiency
- \* Durable Structure

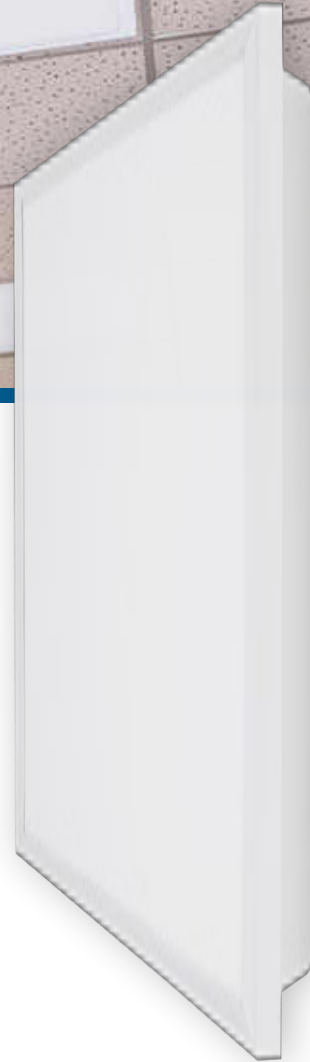

Day & Warm  
Light

**A+**

Energy  
Saving

AI

Aluminium  
Frame



Eco  
Friendly



3000K

4000K

6400K

P. Code	W	TypeLed	☀	⌂	🕒	IP	V	lm	Size (mm)	🔌
KE35560	40	SMD2835	6500	120	25000	20	AC 100-265 V	3600	595x595	4
KE35662	40	SMD2835	4500	120	25000	20	AC 100-265 V	3600	595x595	4
KE35663	40	SMD2835	3000	120	25000	20	AC 100-265 V	3600	595x595	4
KE35561	36	SMD2835	6500	120	25000	20	AC 100-265 V	4320	595x595	4
KE35664	36	SMD2835	4500	120	25000	20	AC 100-265 V	4320	595x595	4
KE35665	36	SMD2835	3000	120	25000	20	AC 100-265 V	4320	595x595	4

# KLAUS®

[www.klauselectric.com](http://www.klauselectric.com)

**Ceiling Lights,  
Smart Lights,  
Strip Leds**



**LED DOWNLIGHT**



Day Light

**A+**

Energy Saving



Ø70-75mm



PBT+PC+Alu Body



Eco Friendly



AC 100-260V

**IP22**

Protection Class

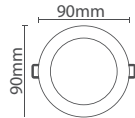

Code	W	Color	Size	lm	Beam
KE36601	3W	6400 K	Ø70mm	240	100
KE36602	5W	6500 K	Ø90mm	400	100
KE36603	7W	6500 K	Ø90mm	560	100
KE36604	9W	6500 K	Ø118mm	720	80
KE36605	12W	6500 K	Ø140mm	960	80

**LED DOWNLIGHT**



Day Light

**A+**

Energy Saving



70-75mm



PBT+PC+Alu Body



Eco Friendly



AC 100-260V

**IP22**

Protection Class

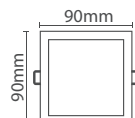

Code	W	Color	Size	lm	Beam
KE36611	3W	6400 K	70x70mm	240	100
KE36612	5W	6500 K	90x90mm	400	100
KE36613	7W	6500 K	90x90mm	560	100
KE36614	9W	6500 K	118x118mm	720	80
KE36615	12W	6500 K	140x140mm	960	80

**LED RAY SPOTLIGHT**



Day Light

**A+**

Energy Saving



AC 110-265V

**IP20**

Protection Class



Code	W	Color	Type Led	Color	Size	Lm	Beam
KE54130	10W	Black	COB	6500 K	62x140mm	900	10
KE54131	20W	Black	COB	6500 K	62x140mm	1800	10
KE54132	30W	Black	COB	6500 K	74x165mm	2700	10
KE54133	40W	Black	COB	6500 K	77x138mm	3600	10
KE54130W	10W	White	COB	6500 K	62x140mm	1800	10
KE54131W	20W	White	COB	6500 K	62x140mm	1800	10
KE54132W	30W	White	COB	6500 K	74x165mm	2700	10
KE54133W	40W	White	COB	6500 K	77x138mm	3600	10



**MR16 ROUND GLASS FRAME**



**GLASS  
FRAME**

Code	Features	Size	
KE36601G	White / Round	90mm Cut:75mm	12

**MR16 ROUND GLASS FRAME**



**GLASS  
FRAME**

Code	Features	Size	
KE36602G	Black / Round	90mm Cut:75mm	12

**MR16 SQUARE GLASS FRAME**



**GLASS  
FRAME**

Code	Features	Size	
KE36603G	White / Round	90mm Cut:75mm	12

**MR16 ROUND GLASS FRAME**



**GLASS  
FRAME**

Code	Features	Size	
KE36604G	Black / Round	90mm Cut:75mm	12

**DOWNLIGHT CASING**

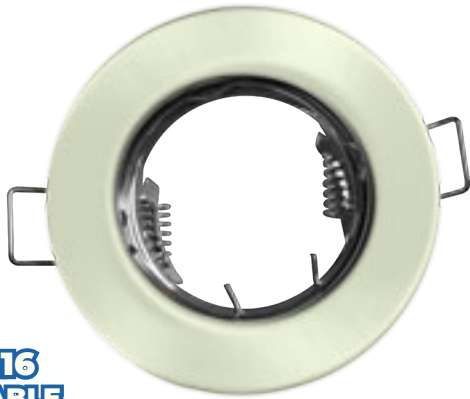

**MR16  
SUITABLE**

Code	W	Features	
KE36601C	Max: 60W	White - IP20	200

**DOWNLIGHT CASING**

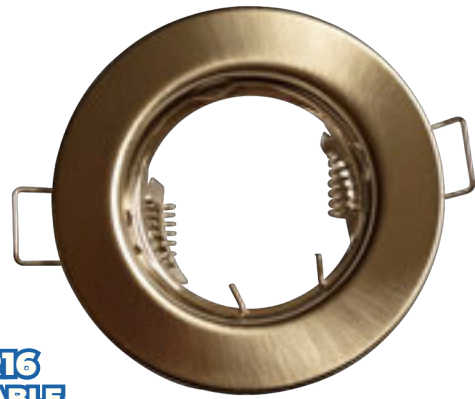

**MR16  
SUITABLE**

Code	W	Features	
KE36602C	Max: 60W	Green Bronz - IP20	200

**DOWNLIGHT CASING**

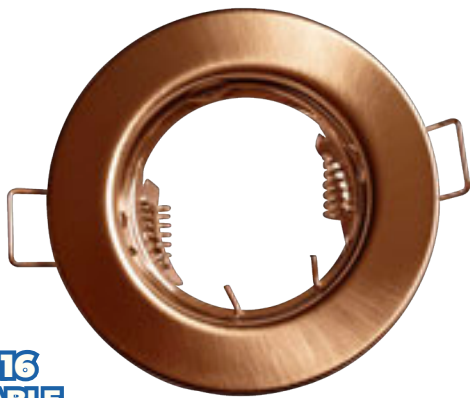

**MR16  
SUITABLE**

Code	W	Features	
KE36603C	Max: 60W	Red Bronze - IP20	200

**DOWNLIGHT CASING**

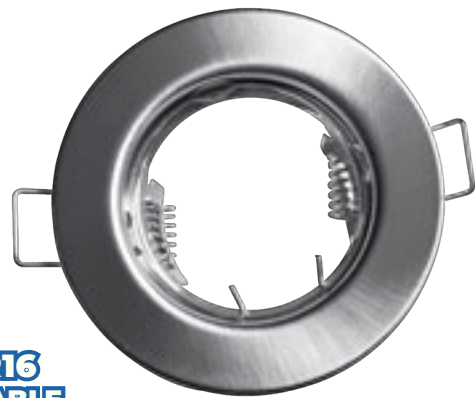

**MR16  
SUITABLE**

Code	W	Features	
KE36604C	Max: 60W	Silver - IP20	200

**DOWNLIGHT CASING**

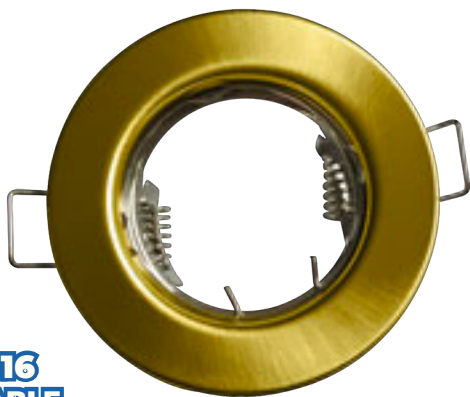

**MR16  
SUITABLE**

Code	W	Features	
KE36605C	Max: 60W	White - IP20	200



**NEW**

**35.000**  
Hours • Years



## LED BULB SMART LIGHT



work with Google Assistant amazon alexa

- Voice-Control Ready
- Remote Access
- No Hub Required
- Schedules
- Smooth Dimming
- 16 Million Colors

Bluetooth®  
  
WiFi

P. Code	W	TypeLed					IP	V	lm	Size (mm)	
KE48603W	10 W	SMD2835	RGB+CW	E27	270	35000	20	AC 185-265 V	1000	Φ60*H120MM	-



**NEW**



## CEILING LAMP SMART LIGHT



easy  
installation



Bluetooth™



work with  Google Assistant  amazon alexa



Voice-Control  
Ready



Remote  
Access

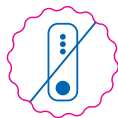

No Hub  
Required

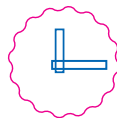





Schedules



Smooth  
Dimming



16 Million  
Colors

P. Code	W	TypeLed				IP	V	lm	Size (mm)	
KE36401W	15 W	SMD2835	RGB+CW	210	35000	20	AC 185-265 V	1500	86*250MM	-
KE36402W	25 W	SMD2835	RGB+CW	210	35000	20	AC 185-265 V	2400	90*230MM	-
KE36403W	15 W	SMD2835	RGB+CW	210	35000	20	AC 185-265 V	1500	86*250MM	-
KE36404W	25 W	SMD2835	RGB+CW	210	35000	20	AC 185-265 V	2400	90*230MM	-

## STRIP LEDS



AC 220-240V

**A+**

Energy Saving



Code	W	☀️	TypeLed	Row Type	LED#	Size	IP	Length	🏠
KE34711	5W/M	6500 K	SMD2835	Single Row	60D	5MM	IP67	100 M.	-
KE34712	5W/M	3000 K	SMD2835	Single Row	60D	5MM	IP67	100 M.	-
KE34713	5W/M	BLUE	SMD2835	Single Row	60D	5MM	IP67	100 M.	-
KE34714	5W/M	RED	SMD2835	Single Row	60D	5MM	IP67	100 M.	-
KE34715	5W/M	GREEN	SMD2835	Single Row	60D	5MM	IP67	100 M.	-
KE34716	5W/M	RGB	SMD5050	Single Row	60D	5MM	IP67	100 M.	-
KE34721	6W/M	6500 K	SMD2835	Single Row	60D	10MM	IP67	100 M.	-
KE34722	6W/M	3000 K	SMD2835	Double Row	120D	10MM	IP67	100 M.	-
KE34723	6W/M	BLUE	SMD2835	Double Row	120D	10MM	IP67	100 M.	-
KE34724	6W/M	RED	SMD2835	Double Row	120D	10MM	IP67	100 M.	-
KE34725	6W/M	GREEN	SMD2835	Double Row	120D	10MM	IP67	100 M.	-
KE34731	7W/M	6500 K	SMD2835	Triple Row	180D	12MM	IP67	100 M.	-
KE34732	7W/M	3000 K	SMD2835	Triple Row	180D	12MM	IP67	100 M.	-
KE34733	7W/M	BLUE	SMD2835	Triple Row	180D	12MM	IP67	100 M.	-
KE34734	7W/M	RED	SMD2835	Triple Row	180D	12MM	IP67	100 M.	-
KE34735	7W/M	GREEN	SMD2835	Triple Row	180D	12MM	IP67	100 M.	-

Code	W	☀️	TypeLed	Led Type	LED#	Size	IP	Length	🏠
KE34801	7W/M	6500 K	SMD2835	Neon Strip Led	120D	10MM	IP67	100 M.	-
KE34802	7W/M	3000 K	SMD2835	Neon Strip Led	120D	10MM	IP67	100 M.	-
KE34803	7W/M	BLUE	SMD2835	Neon Strip Led	120D	10MM	IP67	100 M.	-
KE34804	7W/M	RED	SMD2835	Neon Strip Led	120D	10MM	IP67	100 M.	-
KE34805	7W/M	GREEN	SMD2835	Neon Strip Led	120D	10MM	IP67	100 M.	-
KE34806	8W/M	RGB	SMD5050	RGB Strip Led	120D	10MM	IP67	100 M.	-

Code	Driver Type	Led Type	Ampere	Size	Features	🏠
KE34710D	Led Strip Driver	Single Row	4A	5MM	Connector	-
KE34720D	Led Strip Driver	Double Row	4A	10MM	Connector	-
KE34800D	Led Strip Driver	Neon	4A	10MM	Connector	-
KE34730D	Led Strip Driver	Triple Row	8A	12MM	Connector	-
KE34716D	RGB Led Strip Driver			10MM	Connector w/Button	-
KE34806D	RGB Led Neon Strip Driver			10MM	Connector w/Button	-
KE34716RD	RGB Led Strip Driver			10MM	Connector w/Remote Controller	-
KE34806RD	RGB Led Neon Strip Driver			10MM	Connector w/Remote Controller	-

**LED CEILING LIGHT**



**A+**

Energy Saving



Eco Friendly



Led Type SMD2835



30000 Hours Life



180° Lighting

**IP20**

Protection Class



AC 85-265V

Code	W	☀️	Size	lm	📦
KE36401	12W	6500K	Ø260x100 mm	1080	12
KE36402	18W	6500K	Ø280x100 mm	1620	6
KE36403	24W	6500K	Ø350x100 mm	1920	6

Code	W	☀️	Size	lm	📦
KE36411	12W	4000K	Ø260x100 mm	1080	12
KE36412	18W	4000K	Ø280x100 mm	1620	6
KE36413	24W	4000K	Ø350x100 mm	1920	6

**LED CEILING LIGHT**



**A+**

Energy Saving



Eco Friendly



Led Type SMD2835



30000 Hours Life



180° Lighting

**IP20  
IP54**

Protection Class



AC 85-265V

Code	W	☀️	Size	lm	📦
KE36405	16W	6500K	φ250*40 mm	1280	12
KE36406	24W	6500K	φ320*45 mm	2160	6
KE36407	30W	6500K	φ380*50 mm	2400	6
KE36408	45W	6500K	φ480*55 mm	3600	6

**LED CEILING LIGHT**



**A+**

Energy Saving



Eco Friendly



Led Type SMD2835



30000 Hours Life



180° Lighting

**IP20**

Protection Class



AC 85-265V

Code	W	☀️	Size	lm	📦
KE36431	12W	6500K	210*210*50 mm	960	12
KE36432	18W	6500K	250*250*55 mm	1440	6
KE36433	24W	6500K	320*320*60 mm	1920	6
KE36434	36W	6500K	370*370*70 mm	2880	6



LED CEILING LIGHT



**A+**  
Energy Saving
 Eco Friendly
 Led Type **SMD2835**
 **30000** Hours Life
 **180°** Lighting
 **IP20** Protection Class
 AC 85-265V

Code	W	★	Size	lm	
KE36435	12W	6500K	210*210*50 mm	960	12
KE36436	18W	6500K	250*250*55 mm	1440	6
KE36437	24W	6500K	320*320*60 mm	1920	6
KE36438	36W	6500K	370*370*70 mm	2880	6

LED CEILING LIGHT



**A+**  
Energy Saving
 Eco Friendly
 Led Type **SMD2835**
 **30000** Hours Life
 **180°** Lighting
 **IP20** Protection Class
 AC 85-265V

Code	W	★	Size	lm	
KE36461	12W	6500K	210*210*50 mm	960	12
KE36462	18W	6500K	250*250*55 mm	1440	6
KE36463	24W	6500K	320*320*60 mm	1920	6
KE36464	36W	6500K	370*370*70 mm	2880	6

LED CEILING LIGHT



**A+**  
Energy Saving
 Eco Friendly
 Led Type **SMD2835**
 **30000** Hours Life
 **180°** Lighting
 **IP20**  
**IP54** Protection Class
 AC 85-265V

Code	W	★	Size	lm	
KE36465	16W	6500K	φ250*40 mm	1280	12
KE36466	24W	6500K	φ320*45 mm	2160	6
KE36467	30W	6500K	φ380*50 mm	2400	6
KE36468	45W	6500K	φ480*55 mm	3600	6

LED CEILING LIGHT



**E27**  
**IRON SAND**

**IP44**  
Protection Class

Code	Features	Size	
KE36404	Nickel+Plastic Cover	φ230*80 mm	12

**OUTDOOR LED LIGHTING**

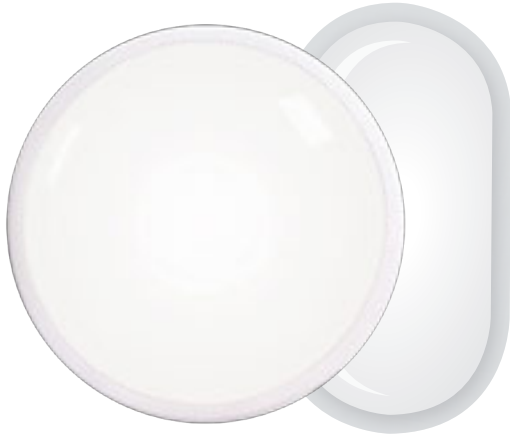

- Day Light
- Led Type SMD2835
- 25000 Hours Life
- 180° Lighting
- AC 100-265V
- IP54 Protection Class
- PP+PP Body
- Eco Friendly
- A+ Energy Saving

Code	W	☀️	Size	lm	☔
KE10202	15W	6500K	Ø167x61	1350	30
KE10203	21W	6500K	Ø222x67	1890	20
KE10205	15W	6500K	214x116x61	1350	30
KE10206	21W	6500K	272x148x75	1890	20

**OUTDOOR LED LIGHTING**



- Day Light
- Led Type SMD2835
- 25000 Hours Life
- 180° Lighting
- IP54 Protection Class
- PP+PP Body
- AC 100-265V
- Eco Friendly
- A+ Energy Saving

Code	W	☀️	Size	lm	☔
KE10211	15W	6500K	Ø167x61	1350	30
KE10212	21W	6500K	Ø167x61	1890	20

**OUTDOOR LED LIGHTING**



- Day Light
- Led Type SMD2835
- 25000 Hours Life
- 120° Lighting
- IP54 Protection Class
- PP+PP Body
- AC 100-265V
- Eco Friendly
- A+ Energy Saving

Code	W	☀️	Size	lm	☔
KE10209	15W	6500K	Ø167x61	1350	30
KE10210	21W	6500K	Ø167x61	1890	20

**OUTDOOR LED LIGHTING**



- Day Light
- Led Type SMD2835
- 25000 Hours Life
- 120° Lighting
- IP54 Protection Class
- PP+PP Body
- AC 100-265V
- Eco Friendly
- A+ Energy Saving

Code	W	☀️	Size	lm	☔
KE10207	15W	6500K	214x116x61	1350	30
KE10208	21W	6500K	272x148x75	1890	20

OUTDOOR LED LIGHTING



- Day Light
- Led Type SMD2835
- 25000 Hours Life
- 120° Lighting
- IP54 Protection Class
- PP+PP Body
- AC 100-265V
- Eco Friendly
- A+ Energy Saving

Code	W		Size	lm	
KE10216	20W	6500K	163x60x205	1800	30

OUTDOOR LED LIGHTING



- Day Light
- Led Type SMD2835
- 25000 Hours Life
- 120° Lighting
- IP54 Protection Class
- PP+PP Body
- AC 100-265V
- Eco Friendly
- A+ Energy Saving

Code	W		Size	lm	
KE10215	20W	6500K	163x60x205	1800	30

OUTDOOR LED LIGHTING



- Day Light
- Led Type SMD2835
- 25000 Hours Life
- 120° Lighting
- IP54 Protection Class
- PP+PP Body
- AC 100-265V
- Eco Friendly
- A+ Energy Saving

Code	W		Size	lm	
KE10214	20W	6500K	163x60x205	1800	30

OUTDOOR LED LIGHTING



- Day Light
- Led Type SMD2835
- 25000 Hours Life
- 120° Lighting
- IP54 Protection Class
- PP+PP Body
- AC 100-265V
- Eco Friendly
- A+ Energy Saving

Code	W		Size	lm	
KE10213	20W	6500K	163x60x205	1800	30



# KLAUS®

[www.klauselectric.com](http://www.klauselectric.com)



**Garden Lights**

UNDERGROUND LED LAMP



Code	W	☼	TypeLed	Size	Lm	☔
KE37602	1W	6500K	SMD2835	70x65 mm	55	50
KE37602G	1W	GREEN	SMD2835	70x65 mm	55	50

UNDERGROUND LED LAMP



Code	W	☼	TypeLed	Size	Lm	☔
KE37603	3W	6500K	SMD2835	80x100 mm	165	30
KE37603G	3W	GREEN	SMD2835	80x100 mm	165	30

UNDERGROUND LED LAMP



Code	W	☼	TypeLed	Size	Lm	☔
KE37604	5W	6500K	SMD2835	80x100 mm	280	20
KE37604G	5W	GREEN	SMD2835	80x100 mm	280	20

UNDERGROUND LED LAMP



Code	Type	Size	Lm	☔
KE37602U	Square	Φ110x130 mm	280	20



**GARDEN SPIKE LAMP**



Code	W	☀️	TypeLed	Size	Lm	☂️
KE37621	5W	6500K	SMD2835	Φ43*H240mm	450	50
KE37631	5W	3000K	SMD2835	Φ43*H240mm	450	50
KE37621G	5W	GREEN	SMD2835	Φ43*H240mm	450	50

**GARDEN SPIKE LAMP**



Code	Features	Size	☂️
KE37621U	Aluminium Body	Φ98x90x300mm	20





**WALL LIGHT**



**IP54**  
**ALU+  
GLASS**

Code	Type	Size	
KE46401U	Round	68x92x150mm	20

**WALL LIGHT**



**IP54**  
**ALU+  
GLASS**

Code	Type	Size	
KE46402U	Square	68x92x150mm	20

**WALL LIGHT**



**ALU+  
GLASS**

Code	W		TypeLed	Size	Lm	
KE46403U	-	-	-	65x65x260mm	-	20

**WALL LIGHT**



**IP20**

Code	Type	Size	
KE46404U	Round	Φ93x102mm	50

**WALL LIGHT**



**IP20**

Code	Type	Size	
KE46405U	Square	93x93x102mm	50

**WALL LIGHT**



**IP20**

Code	Type	Size	
KE46406U	Round	Φ108x110mm	60

**GARDEN LIGHT**



**IP54**

Code	Features	Size	
KE46201B	AC 220-240V	200x160x380mm	12

**WALL LIGHT**



**IP54**

Code	Features	Size	
KE46203B	AC 220-240V	160x160x500mm	12

**STEP LIGHT**



**ALU+  
PLASTIC**

Code	Features	Size	
KE465501	E27 HOLDER	233X101mm	25

**STEP LIGHT**



**ALU+  
STEEL**

Code	Features		Size	
KE465502	100V-240V	6500K	110X45mm	50
KE465512	100V-240V	3000K	110X45mm	50

**STEP LIGHT**



**ALU+  
STEEL**

Code	Features		Size	
KE465502	100V-240V	6500K	170X70x86mm	50
KE465512	100V-240V	3000K	170X70x86mm	50





# KLAUS®

[www.klauselectric.com](http://www.klauselectric.com)



**Ventilation Equipments**

### FRONT SHUTTER EXHAUST FAN

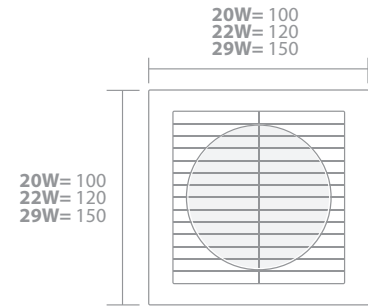

- \* Noise <=25/30/35 db
- \* Security: 220V/50Hz

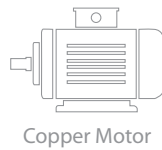

P. Code	W	V	Size (mm)	⌘
KE39304	20W	220 V	Ø 100mm	24
KE39305	22W	220 V	Ø 120mm	24
KE39306	29W	220 V	Ø 150mm	12

### BACK SHUTTER EXHAUST FAN

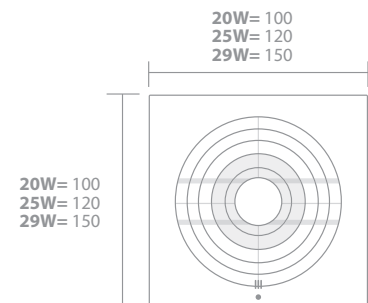

- \* Noise <=25/30/35 db
- \* Security: 220V/50Hz

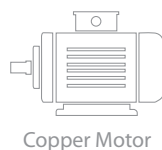

P. Code	W	V	Size (mm)	⌘
KE39307	20W	220 V	Ø 100mm	24
KE39308	25W	220 V	Ø 120mm	24
KE39309	29W	220 V	Ø 150mm	12



**EXHAUST FAN**

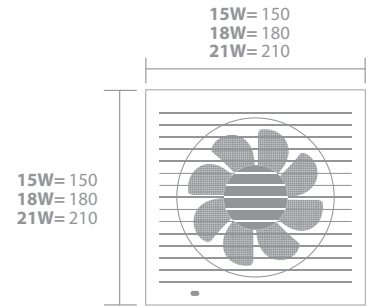

- \* Noise <=40 db
- \* Security: 220V/60Hz

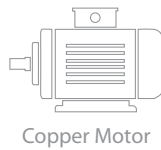

P. Code	W	V	Size (mm)	⌘
KE39301	15W	AC 220-240V	150x150	24
KE39302	18W	AC 220-240V	180x180	24
KE39303	21W	AC 220-240V	210x210	12

**EXHAUST FAN**

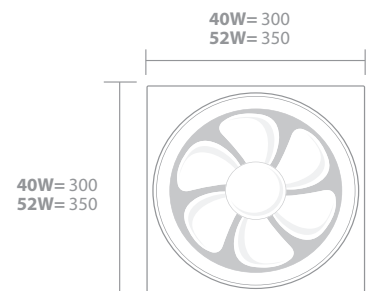

- \* Noise <=25/30/35 db
- \* Security: 220V/50Hz

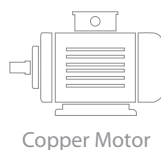

P. Code	W	V	Size (mm)	⌘
KE39401	40W	220 V	Ø 300mm	6
KE39402	52W	220 V	Ø 350mm	6



EXHAUST FAN

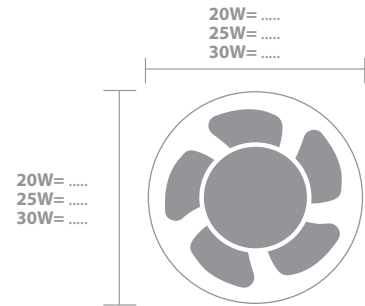

- \* 180 M<sup>3</sup> /h / 1975 Rpm
- \* Noise <=34 db
- \* Security: 220V/60Hz

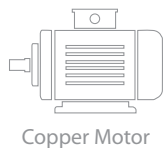

P. Code	W	V	Size (mm)	⌘
KE39501	20W	AC 220-240V	100x100	30
KE39502	25W	AC 220-240V	125x125	30
KE39503	30W	AC 220-240V	150x150	16

EXHAUST FAN

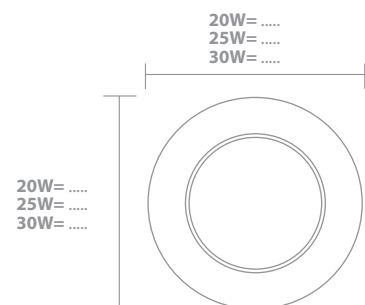

- \* 180 M<sup>3</sup> /h / 1975 Rpm
- \* Noise <=34 db
- \* Security: 220V/60Hz

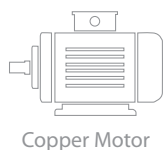

P. Code	W	V	Size (mm)	⌘
KE39310	20W	AC 220-240V	100x100	30
KE39311	25W	AC 220-240V	125x125	30
KE39312	30W	AC 220-240V	150x150	16

**EXHAUST FAN**

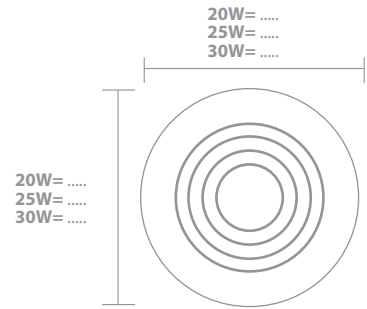

- \* 180 M<sup>3</sup> /h / 1975 Rpm
- \* Noise <=34 db
- \* Security: 220V/60Hz

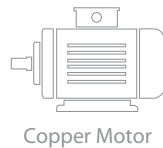

P. Code	W	V	Size (mm)	
KE39313	20W	AC 220-240V	Ø 100	30
KE39314	25W	AC 220-240V	Ø 125	30
KE39315	30W	AC 220-240V	Ø 150	16

**EXHAUST FAN**

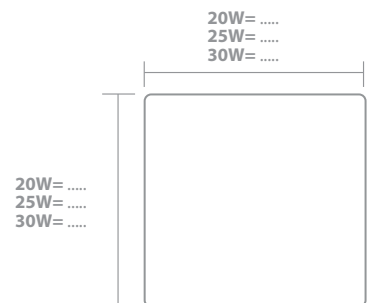

- \* 180 M<sup>3</sup> /h / 1975 Rpm
- \* Noise <=34 db
- \* Security: 220V/60Hz

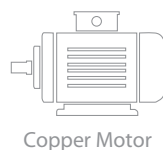

P. Code	W	V	Size (mm)	
KE39316	20W	AC 220-240V	100x100	30
KE39317	25W	AC 220-240V	125x125	30
KE39318	30W	AC 220-240V	150x150	16

**16" STAND FAN**



P. Code	W	V	Features	
KE39101	45W	AC 220-240V	1250 R/Min	6

**EXHAUST FAN**



P. Code	W	V	Features	
KE39102	65W	AC 220-240V	1250 R/Min	6

**CEILING FAN**

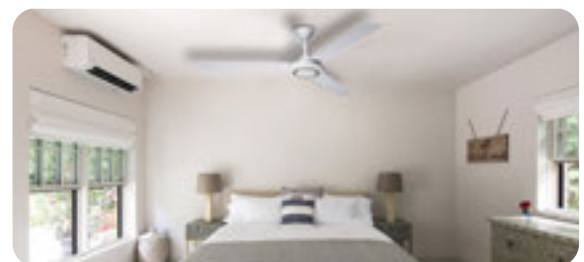

P. Code	W	V	Features	
KE56XF	75W	AC 220-240V	280/300 R/Min	5/40



# KLAUS®

[www.klauselectric.com](http://www.klauselectric.com)



**Circuit Breakers**



1 Pole

## MINIATURE CIRCUIT BREAKER (MCB)

IEC/EN 60898-1 \*

Inc 4500A \*

C Curve \*

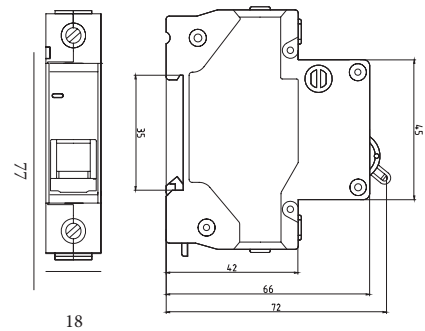

P. Code	Rated Current (A)	Tripping Type	Breaking Capacity	⌚	IP	Rated Working Voltage	Size (mm)	☔
KE40106	6A	C	4.5 kA	90000	20	230/400V ~	18x77	180
KE40108	8A	C	4.5 kA	90000	20	230/400V ~	18x77	180
KE40110	10A	C	4.5 kA	90000	20	230/400V ~	18x77	180
KE40113	13A	C	4.5 kA	90000	20	230/400V ~	18x77	180
KE40116	16A	C	4.5 kA	90000	20	230/400V ~	18x77	180
KE40120	20A	C	4.5 kA	90000	20	230/400V ~	18x77	180
KE40125	25A	C	4.5 kA	90000	20	230/400V ~	18x77	180
KE40132	32A	C	4.5 kA	90000	20	230/400V ~	18x77	180
KE40140	40A	C	4.5 kA	90000	20	230/400V ~	18x77	180
KE40150	50A	C	4.5 kA	90000	20	230/400V ~	18x77	180
KE40163	63A	C	4.5 kA	90000	20	230/400V ~	18x77	180

**2 Pole**

# MINIATURE CIRCUIT BREAKER (MCB)

- \* IEC/EN 60898-1
- \* Inc 4500A
- \* C Curve

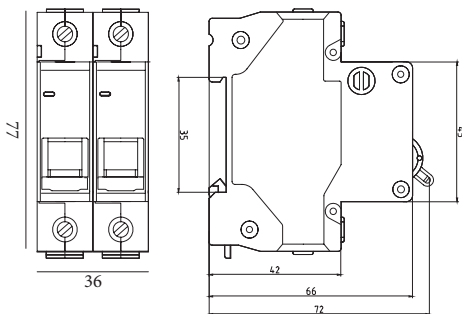

P. Code	Rated Current (A)	Tripping Type	Breaking Capacity	⌚	IP	Rated Working Voltage	Size (mm)	☔
KE40206	6A	C	4.5 kA	90000	20	400V ~	36x77	90
KE40208	8A	C	4.5 kA	90000	20	400V ~	36x77	90
KE40210	10A	C	4.5 kA	90000	20	400V ~	36x77	90
KE40213	13A	C	4.5 kA	90000	20	400V ~	36x77	90
KE40216	16A	C	4.5 kA	90000	20	400V ~	36x77	90
KE40220	20A	C	4.5 kA	90000	20	400V ~	36x77	90
KE40225	25A	C	4.5 kA	90000	20	400V ~	36x77	90
KE40232	32A	C	4.5 kA	90000	20	400V ~	36x77	90
KE40240	40A	C	4.5 kA	90000	20	400V ~	36x77	90
KE40250	50A	C	4.5 kA	90000	20	400V ~	36x77	90
KE40263	63A	C	4.5 kA	90000	20	400V ~	36x77	90





3 Pole



## MINIATURE CIRCUIT BREAKER (MCB)

- IEC/EN 60898-1 \*
- Inc 4500A \*
- C Curve \*

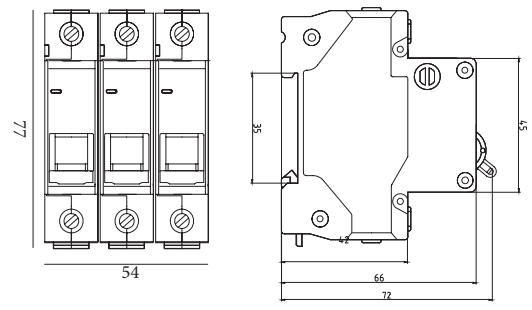

P. Code	Rated Current (A)	Tripping Type	Breaking Capacity	⌚	IP	Rated Working Voltage	Size (mm)	☔
KE40306	6A	C	4.5 kA	90000	20	400V ~	54x77	60
KE40308	8A	C	4.5 kA	90000	20	400V ~	54x77	60
KE40310	10A	C	4.5 kA	90000	20	400V ~	54x77	60
KE40313	13A	C	4.5 kA	90000	20	400V ~	54x77	60
KE40316	16A	C	4.5 kA	90000	20	400V ~	54x77	60
KE40320	20A	C	4.5 kA	90000	20	400V ~	54x77	60
KE40325	25A	C	4.5 kA	90000	20	400V ~	54x77	60
KE40332	32A	C	4.5 kA	90000	20	400V ~	54x77	60
KE40340	40A	C	4.5 kA	90000	20	400V ~	54x77	60
KE40350	50A	C	4.5 kA	90000	20	400V ~	54x77	60
KE40363	63A	C	4.5 kA	90000	20	400V ~	54x77	60

**4 Pole**

# MINIATURE CIRCUIT BREAKER (MCB)

- \* IEC/EN 60898-1
- \* Inc 4500A
- \* C Curve

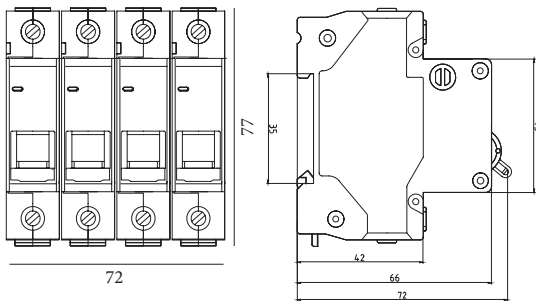

P. Code	Rated Current (A)	Tripping Type	Breaking Capacity	⌚	IP	Rated Working Voltage	Size (mm)	☔
KE40406	6A	C	4.5 kA	90000	20	400V ~	72x77	45
KE40408	8A	C	4.5 kA	90000	20	400V ~	72x77	45
KE40410	10A	C	4.5 kA	90000	20	400V ~	72x77	45
KE40413	13A	C	4.5 kA	90000	20	400V ~	72x77	45
KE40416	16A	C	4.5 kA	90000	20	400V ~	72x77	45
KE40420	20A	C	4.5 kA	90000	20	400V ~	72x77	45
KE40425	25A	C	4.5 kA	90000	20	400V ~	72x77	45
KE40432	32A	C	4.5 kA	90000	20	400V ~	72x77	45
KE40440	40A	C	4.5 kA	90000	20	400V ~	72x77	45
KE40450	50A	C	4.5 kA	90000	20	400V ~	72x77	45
KE40463	63A	C	4.5 kA	90000	20	400V ~	72x77	45

4 Pole  
(3 Pole+N)





## RESIDUAL CURRENT CIRCUIT BREAKER (RCCB)

IEC/EN 61008-1 \*

Inc 6000A \*

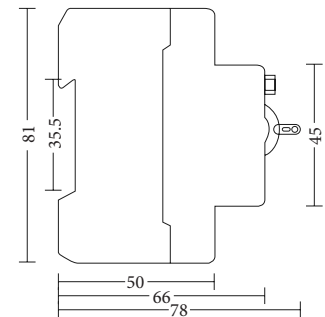
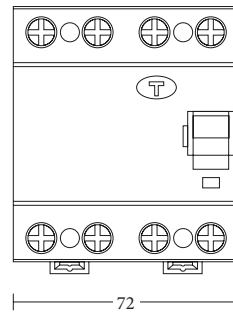
Type AC \*



P. Code	Rated Current (A)	Tripping Type	Breaking Capacity	Electrical Life	Mechanical Life	IP	Rated Working Voltage	Size (mm)	
KE41416	16A	AC	6kA	6000 Cycles	20000 Cycles	20	400V ~	72x81	45
KE41425	25A	AC	6kA	6000 Cycles	20000 Cycles	20	400V ~	72x81	45
KE41432	32A	AC	6kA	6000 Cycles	20000 Cycles	20	400V ~	72x81	45
KE41440	40A	AC	6kA	6000 Cycles	20000 Cycles	20	400V ~	72x81	45
KE41450	50A	AC	6kA	6000 Cycles	20000 Cycles	20	400V ~	72x81	45
KE41463	63A	AC	6kA	6000 Cycles	20000 Cycles	20	400V ~	72x81	45



2 Pole  
(1 Pole+N)

## RESIDUAL CURRENT CIRCUIT BREAKER (RCCB)

- \* IEC/EN 61008-1
- \* Inc 6000A
- \* Type AC

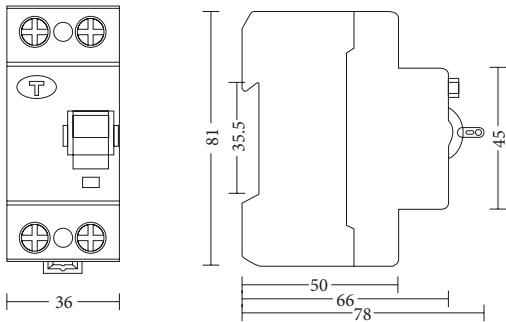

P. Code	Rated Current (A)	Tripping Type	Breaking Capacity	⌚	IP	Rated Working Voltage	Size (mm)	🔩
KE40406	6A	C	4.5 kA	90000	20	400V ~	72x77	45
KE40408	8A	C	4.5 kA	90000	20	400V ~	72x77	45
KE40410	10A	C	4.5 kA	90000	20	400V ~	72x77	45
KE40413	13A	C	4.5 kA	90000	20	400V ~	72x77	45
KE40416	16A	C	4.5 kA	90000	20	400V ~	72x77	45
KE40420	20A	C	4.5 kA	90000	20	400V ~	72x77	45
KE40425	25A	C	4.5 kA	90000	20	400V ~	72x77	45
KE40432	32A	C	4.5 kA	90000	20	400V ~	72x77	45
KE40440	40A	C	4.5 kA	90000	20	400V ~	72x77	45
KE40450	50A	C	4.5 kA	90000	20	400V ~	72x77	45
KE40463	63A	C	4.5 kA	90000	20	400V ~	72x77	45

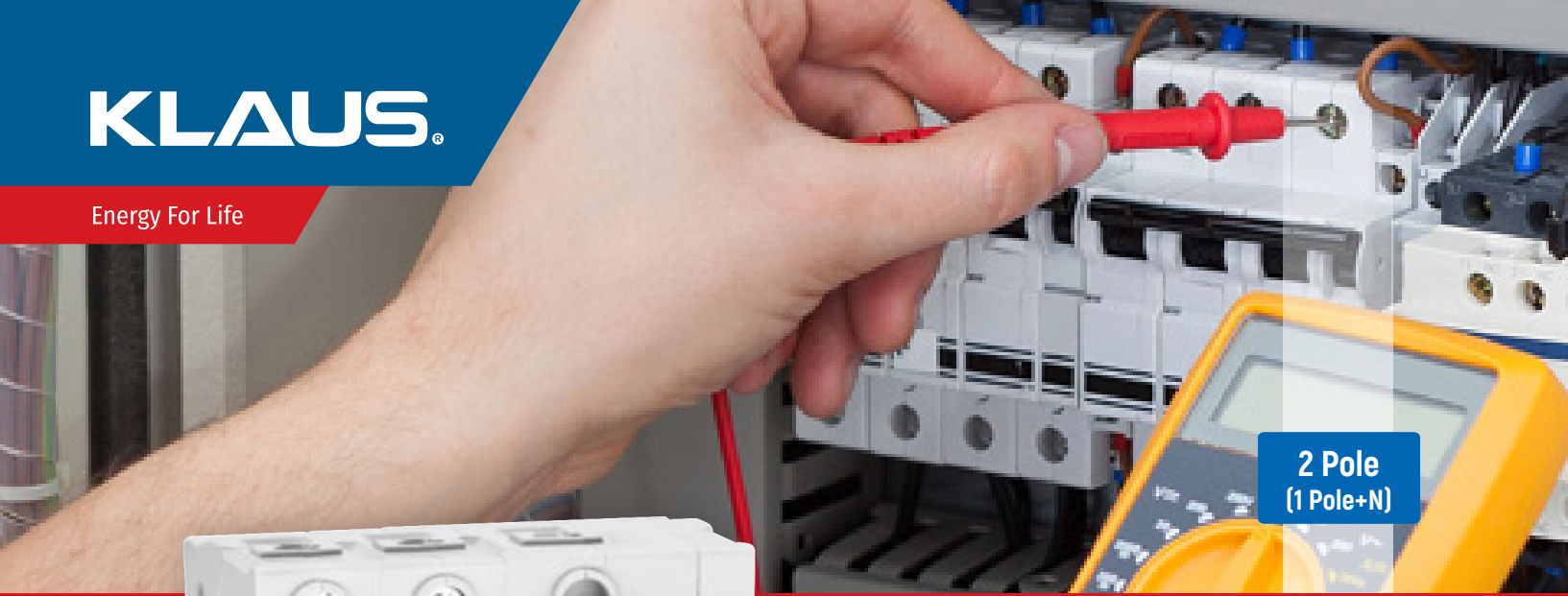

2 Pole  
(1 Pole+N)



## RESIDUAL CURRENT CIRCUIT BREAKER (RCBO)

IEC/EN 61008-1 \*

I<sub>nc</sub> 6000A \*

Type AC \*

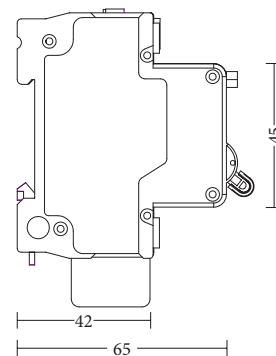
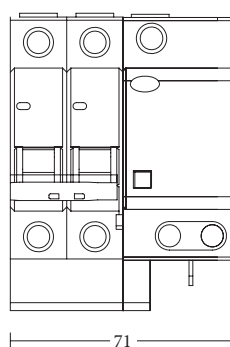

P. Code	Rated Current (A)	Tripping Type	Breaking Capacity	⌚	IP	Rated Working Voltage	Size (mm)	☔
KE42206	6A	C	4.5 kA	90000	20	500V ~	66x94	54
KE42210	1A	C	4.5 kA	90000	20	500V ~	66x94	54
KE42216	16A	C	4.5 kA	90000	20	500V ~	66x94	54
KE42220	20A	C	4.5 kA	90000	20	500V ~	66x94	54
KE42225	25A	C	4.5 kA	90000	20	500V ~	66x94	54
KE42232	32A	C	4.5 kA	90000	20	500V ~	66x94	54
KE42240	40A	C	4.5 kA	90000	20	500V ~	66x94	54
KE42250	50A	C	4.5 kA	90000	20	500V ~	66x94	54
KE42263	63A	C	4.5 kA	90000	20	500V ~	66x94	54

4 Pole  
(3 Pole+N)

## RESIDUAL CURRENT CIRCUIT BREAKER (RCBO)

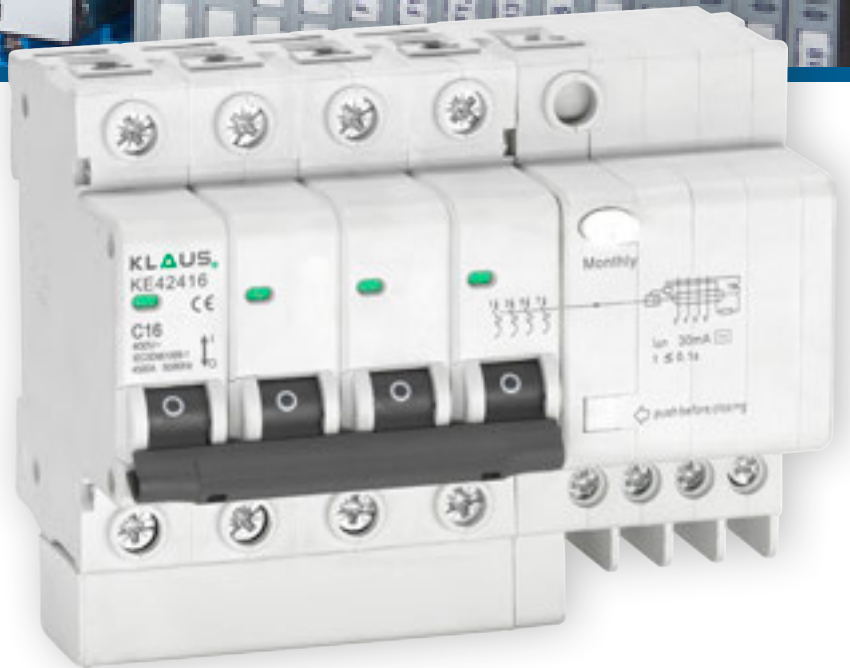

- \* IEC/EN 60898-1
- \* Inc 4500A
- \* C Curve

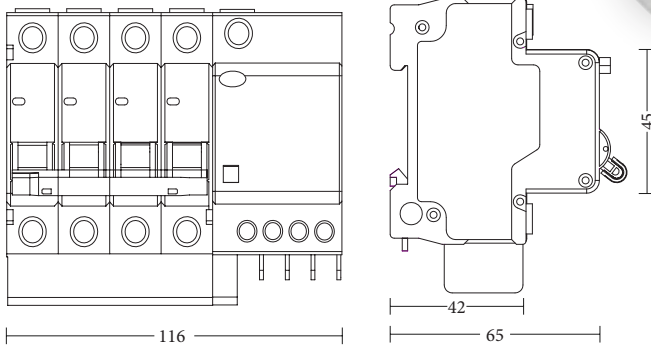

P. Code	Rated Current (A)	Tripping Type	Breaking Capacity	⌚	IP	Rated Working Voltage	Size (mm)	☔
KE42406	6A	C	4.5 kA	90000	20	500V ~	66x94	54
KE42410	1A	C	4.5 kA	90000	20	500V ~	66x94	54
KE42416	16A	C	4.5 kA	90000	20	500V ~	66x94	54
KE42420	20A	C	4.5 kA	90000	20	500V ~	66x94	54
KE42425	25A	C	4.5 kA	90000	20	500V ~	66x94	54
KE42432	32A	C	4.5 kA	90000	20	500V ~	66x94	54
KE42440	40A	C	4.5 kA	90000	20	500V ~	66x94	54
KE42450	50A	C	4.5 kA	90000	20	500V ~	66x94	54
KE42463	63A	C	4.5 kA	90000	20	500V ~	66x94	54
KE42450	50A	C	4.5 kA	90000	20	400V ~	72x77	45
KE42463	63A	C	4.5 kA	90000	20	400V ~	72x77	45



# KLAUS®

[www.klauselectric.com](http://www.klauselectric.com)

**Table Lamps,  
Flashlights, Accessories**



**TABLE LAMP**



Code	Features	V	
KE38600	2 mt. Cable / Red	AC 220-240 V	20
KE38601	2 mt. Cable / Black	AC 220-240 V	20
KE38602	2 mt. Cable / Blue	AC 220-240 V	20

**TABLE LAMP**



Code	Features	V	
KE38603	Red	AC 220-240 V	12
KE38604	Black	AC 220-240 V	12
KE38605	White	AC 220-240 V	12

**TABLE LAMP**



Battery Voltage:  
3.7 V

Charging Time:  
2-5 Hours

Endurance Time:  
3-9 Hours 300 mAh



**Three Step Dimming**



Low Power



Medium Power



High Power

Code		V	
KE38606	6500K	AC 220-240 V	120

TABLE LAMP



Charging  
110-240V  
2mt. Cable  
& USB Plug

Working Time:  
8 Hours

80 Lumens  
800-1000 mAh

Push Button  
Dimming



Code	☀️	V	🏠
KE38607	6500K-4000K-3000K	AC 110-240 V	70

**THREE  
COLOR  
OPTION**

TABLE LAMP

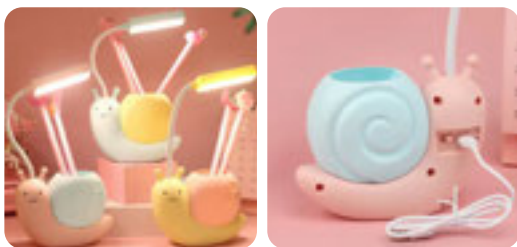

110-240V  
2mt. Cable  
& USB Plug

Soft  
Light Eye  
Protection

360°  
Rotatable



Code	☀️	V	🏠
KE38608	4000K	AC 110-240 V	120
KE38609	4000K	AC 110-240 V	120





**LED RECHARGEABLE EMERGENCY LAMP**



- SMD LED**  
108 PCS
- Dual Stage Lighting**
- 3600mAh**  
Lead Acid Battery
- Rechargeable**

Code	W	⚡	⌚	V	Lm	☂
KE47712	33W	6500K	25000	AC 90-240 V	2500	30

**RECHARGEABLE FLASHLIGHT**



- SUPER LED**  
1+10
- 25m**  
Lighting Distance
- 600mAh**  
Lead Acid Battery
- Rechargeable**

Code	W	⚡	⌚	V	Lm	☂
KE47711	3W	6500K	25000	AC 90-240 V	240	120

**LED CAMP LIGHT**



- SMD LED**  
10 PCS
- Dual Stage Lighting**
- 3000mAh**  
Lead Acid Battery
- Rechargeable**

Code	W	⚡	⌚	V	Lm	☂
KE47702	6W	6500K	25000	AC 90-240 V	300	54

**LED CAMP LIGHT**

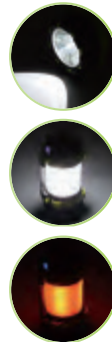

- SUPER LED**  
20+40
- 4000mAh**  
Lead Acid Battery
- Rechargeable**

Code	W	⚡	⌚	V	Lm	☂
KE47703	8+5W	6500K	25000	AC 90-240 V	260+450	36

**RECHARGEABLE FLASHLIGHT**



**1600 mAh**
 Rechargeable
 **LI-ON BATTERY**

Code	W	☼	⌚	V	Lm	☂
KE47713	3W	6500K	25000	AC 90-240 V	240	60

**RECHARGEABLE FLASHLIGHT**



**6000 mAh**
 Rechargeable
 **LI-ON BATTERY**

Code	W	☼	⌚	V	Lm	☂
KE47714	8W	6500K	25000	AC 90-240 V	1200	120

**RECHARGEABLE FLASHLIGHT**



**4800 mAh**
 Rechargeable
 **LI-ON BATTERY**
**USB**

Code	W	☼	⌚	V	Lm	☂
KE47715	5W	6500K	25000	AC 90-240 V	600	60

**LED CAMPLIGHT**



**9600 mAh**
 Rechargeable
 **LI-ON BATTERY**
**T6**

Code	W	☼	⌚	V	Lm	☂
KE47716	20W	6500K	25000	AC 90-240 V	1000	120

**RECHARGEABLE FLASHLIGHT**



**2400 mAh**
**Rechargeable**
**LI-ON BATTERY**

Code	W	☼	⌚	Lm	☂
KE47710	5W	6500K	25000	-	-

**RECHARGEABLE FLASHLIGHT**



**LI-ON BATTERY**
**1800 mAh**
**Rechargeable**

Code	W	☼	⌚	Lm	☂
KE47717	3W	6500K	25000	350	240

**LED NIGHT LAMP**



**2 Watt**  
**4 LED CHIP**

**%90 SAVING**

Code	W	☼	⌚	Lm	☂
KE26501	2W	6500K	25000	-	-

**LED FLASHLIGHT**



**120 LUMEN**
**3 Watt**
**LED TYPE: 1\*SMD+ 2\*COB**
**MAGNETIC**
**3xAAA BATTERY**

Code	W	☼	⌚	Lm	☂
KE47707	2+1W	6500K	25000	120	200



**LED FLASHLIGHT**



**70 LUMEN** **LED TYPE: XPE** **1 Watt** **3xAAA BATTERY**

Code	W	☼	🕒	Energy	Lm	☂
KE47700	1W	6500K	25000	3pcs AAA Battery	70	240

**LED FLASHLIGHT**



**LED TYPE: XPE+COB** **3+1 Watt** **Rechargeable** **USB CHARGER**

Code	W	☼	🕒	Lm	☂
KE47701	3W +1W	6500K	25000	90+60Lm	240

**LED STICKER WALL LIGHT**



Code	W	☼	🕒	Lm	☂
KE47709	1W	6500K	25000	80	360

**LED NIGHT LAMP**



**60 LUMEN** **LED TYPE: 1\*COB** **4xAAA BATTERY**

Code	W	☼	🕒	Lm	☂
KE47708	1W	6500K	25000	80	192

## LED HEADLIGHT



Code	W	★	🕒	Lm	☔
KE47704	1+3W	6500K	25000	50+80	240

## LED HEADLIGHT



Code	W	★	🕒	Lm	☔
KE47705	5W	6500K	25000	120Lm	100

## LED HEADLIGHT



Code	W	★	🕒	Lm	☔
KE47706	1+1W	6500K	25000	80	240



## TERMINAL BLOCK SLOT SCREW



10 PCS.

Code	Features	
KE44604	12P 3A/380V 4MM <sup>2</sup>	150
KE44606	12P 5A/380V 6MM <sup>2</sup>	150
KE44610	12P 10A/380V10MM <sup>2</sup>	120
KE44612	12P 15A/380V12MM <sup>2</sup>	100
KE44614	12P 20A/380V14MM <sup>2</sup>	70
KE44616	12P 30A/380V16MM <sup>2</sup>	50
KE44625	12P 60A/380V25MM <sup>2</sup>	30
KE44701	3P 15A/600V1.5MM <sup>2</sup>	100
KE44702	4P 15A/600V1.5MM <sup>2</sup>	80
KE44703	5P 15A/600V1.5MM <sup>2</sup>	60
KE44704	6P 15A/600V1.5MM <sup>2</sup>	40
KE44705	10P 15A/600V1.5MM <sup>2</sup>	50
KE44706	12P 15A/600V1.5MM <sup>2</sup>	30
KE44707	3P 25A/600V2.5MM <sup>2</sup>	100
KE44708	4P 25A/600V2.5MM <sup>2</sup>	60
KE44709	5P 25A/600V2.5MM <sup>2</sup>	60
KE44710	6P 25A/600V2.5MM <sup>2</sup>	60
KE44711	10P 25A/600V2.5MM <sup>2</sup>	30
KE44712	12P 25A/600V2.5MM <sup>2</sup>	30
KE44713	3P 35A/600V2.5MM <sup>2</sup>	80
KE44714	4P 35A/600V2.5MM <sup>2</sup>	60
KE44715	5P 35A/600V2.5MM <sup>2</sup>	40
KE44716	6P 35A/600V2.5MM <sup>2</sup>	40
KE44717	10P 35A/600V2.5MM <sup>2</sup>	20
KE44718	12P 35A/600V2.5MM <sup>2</sup>	20
KE44719	3P 45A/600V4.0MM <sup>2</sup>	40
KE44720	4P 45A/600V4.0MM <sup>2</sup>	25
KE44721	5P 45A/600V4.0MM <sup>2</sup>	25
KE44722	6P 45A/600V4.0MM <sup>2</sup>	20
KE44723	10P 45A/600V4.0MM <sup>2</sup>	10
KE44724	12P 45A/600V4.0MM <sup>2</sup>	10
KE44801	6P 6X9MM <sup>2</sup>	700
KE44802	8P 6X9MM <sup>2</sup>	500
KE44803	10P 6X9MM <sup>2</sup>	500
KE44804	12P 6X9MM <sup>2</sup>	500
KE44805	6P 6X9MM <sup>2</sup>	700
KE44806	8P 6X9MM <sup>2</sup>	500
KE44807	10P 6X9MM <sup>2</sup>	500
KE44808	12P 6X9MM <sup>2</sup>	500
KE44809	6P 6X9MM <sup>2</sup>	500
KE44810	8P 6X9MM <sup>2</sup>	500
KE44811	10P 6X9MM <sup>2</sup>	500
KE44812	12P 6X9MM <sup>2</sup>	500
KE44813	14P 6X9MM <sup>2</sup>	500
KE44814	16P 6X9MM <sup>2</sup>	400

## ROUND CABLE CLIP

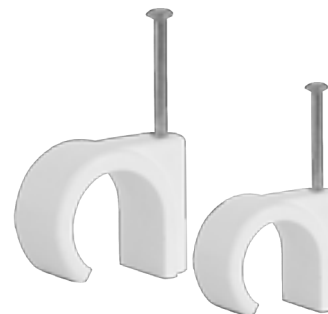

Код	Характеристики	
KE44105	5MM Round	50
KE44106	6MM Round	50
KE44107	7MM Round	50
KE44108	8MM Round	50
KE44109	9MM Round	50
KE44110	10MM Round	50
KE44112	12MM Round	50
KE44114	14MM Round	50
KE44116	16MM Round	50

## SQUARE CABLE CLIP



Код	Характеристики	
KE44205	5MM Flat	50
KE44206	6MM Flat	50
KE44207	7MM Flat	50
KE44208	8MM Flat	50
KE44209	9MM Flat	50
KE44210	10MM Flat	50
KE44212	12MM Flat	50
KE44214	14MM Flat	50
KE44216	16MM Flat	50



### WIRE CONNECT



32A/250V

32A/450V

Код	Характеристики	
KE44401	2P 2.5MM <sup>2</sup> White	50
KE44402	3P 2.5MM <sup>2</sup> White	50
KE44502	2P 2.5MM <sup>2</sup> Gray	50
KE44503	3P 2.5MM <sup>2</sup> Gray	50
KE44504	4P 2.5MM <sup>2</sup> Gray	50
KE44505	5P 2.5MM <sup>2</sup> Gray	50
KE44508	8P 2.5MM <sup>2</sup> Gray	50
KE44512	2P 4MM <sup>2</sup> Orange	50
KE44513	3P 4MM <sup>2</sup> Orange	50
KE44514	4P 4MM <sup>2</sup> Orange	50
KE44515	5P 4MM <sup>2</sup> Orange	50

### NETWORK CABLE

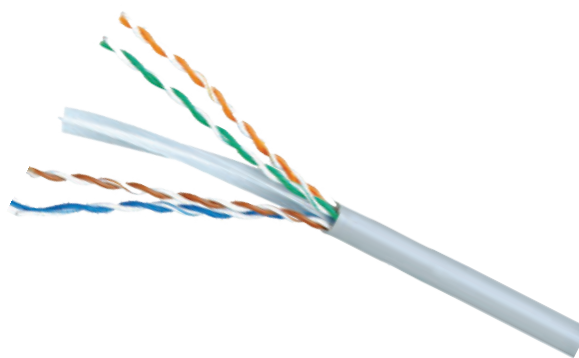

CAT5

Код	Характеристики	
KE36550	0,51 mm, 4cc+4cca	2pcs*305m.

### HEAT SHRINK TUBE



Код	Характеристики	
KE44901	Φ1.0	20
KE44902	Φ1.5	20
KE44903	Φ2.0	20
KE44904	Φ2.5	20
KE44905	Φ3.0	20

### INSULATED TERMINAL



Код	Характеристики	
KE44301	0.75 MM <sup>2</sup> 8MM	100
KE44302	1.0 MM <sup>2</sup> 8MM	100
KE44303	1.5 MM <sup>2</sup> 8MM	100
KE44304	2.5 MM <sup>2</sup> 8MM	100
KE44305	4.0 MM <sup>2</sup> 9MM	100
KE44306	4.0 MM <sup>2</sup> 12MM	100
KE44307	6.0 MM <sup>2</sup> 12MM	100

**LAMP HOLDER**



Code	Features	
KE43101	Ceramics, E27	400

**LAMP HOLDER**



Code	Features	
KE43105	Plastic, E27	10/400

**LAMP HOLDER**



Code	Features	
KE43104	Plastic, E27	12/300

**LAMP HOLDER**



Code	Features	
KE43103	Plastic, E27	20/600

**LAMP HOLDER**



Code	Features	
KE43102	Plastic, E14	50/1000



**LAMP HOLDER WITH SENSOR**

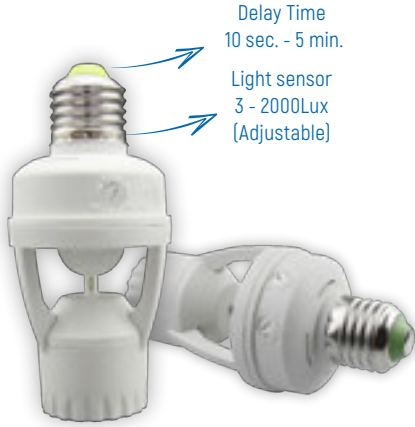

Code	Features	
KE57101	360° Motion Sensor	50

Code	Features	
KE57102	360° Motion Sensor	12

Code	Features	
KE57102	360° Motion Sensor	12

**PHOTOCELL**



Code	Features	
KE57104	<5-15 LUX	50

**PHOTOCELL**



Code	Features	
KE57105	<5-15 LUX - 10A	50

**PHOTOCELL**



Code	Features	
KE57108	<5-15 LUX - 25A	50

**PIR SENSOR**



Code	Features	
KE57106	<10-2000 LUX	100

**PIR SENSOR**



Code	Features	
KE57107	<10-2000t LUX	100



**AUTOMATIC SWITCH BOXES FOR OUTDOOR INSTALLATION**



Code	Features	
KE29110104	Surface Box 2 Way	30
KE29110106	Surface Box 2-6 Way	30
KE29110109	Surface Box 9 Way	30
KE29110112	Surface Box 12 Way	20
KE29110116	Surface Box 16-18 Way	20
KE29110124	Surface Box 24 Way	10
KE29110132	Surface Box 32-36 Way	10

**AUTOMATIC SWITCH BOXES FOR INDOOR INSTALLATION**



Code	Features	
KE29110204	Flush Fuse Box 2Way	30
KE29110206	Flush Fuse Box 2-6 Way	30
KE29110209	Flush Fuse Box 9 Way	30
KE29110212	Flush Fuse Box 12 Way	20
KE29110216	Flush Fuse Box 16-18 Way	20
KE29110224	Flush Fuse Box 24 Way	10
KE29110232	Flush Fuse Box 32-36 Way	10

**CIRCUIT BREAKER BOXES**



Code	Features	
KE29110102	Surface Box 1-2 Way	20
KE29110103	Surface Box 3-4 Way	30

## EXTENSION CABLE REEL



Code	Features	
KE30120	20 M, 3x1mm <sup>2</sup>	4
KE30130	30 M, 3x1mm <sup>2</sup>	4
KE30150	50 M, 3x1mm <sup>2</sup>	2
KE30220	20 M, 3x1,5mm <sup>2</sup>	4
KE30230	30 M, 3x1,5mm <sup>2</sup>	4
KE30250	50 M, 3x1,5mm <sup>2</sup>	2
KE30320	20 M, 3x2.5mm <sup>2</sup>	4
KE30330	30 M, 3x2.5mm <sup>2</sup>	4
KE30350	50 M, 3x2.5mm <sup>2</sup>	2
KEM98	Max. 50 M, Empty Coil	1

## EXTENSION SOCKETS



Code	Features	
AE35200	2 Way, Wireless	42/168
AE35202	2 Way, Wired, 2 MT	22/88
AE35203	2 Way, Wired, 3 MT	19/76
AE35205	2 Way, Wired, 5 MT	18/72
AE35300	3 Way, Wireless	35/140
AE35302	3 Way, Wired, 2 MT	19/76
AE35303	3 Way, Wired, 3 MT	18/72
AE35305	3 Way, Wired, 5 MT	16/64
AE35400	4 Way, Wireless	28/112
AE35402	4 Way, Wired, 2 MT	16/64
AE35403	4 Way, Wired, 3 MT	15/60
AE35405	4 Way, Wired, 5 MT	14/56
AE35500	5 Way, Wireless	24/96
AE35502	5 Way, Wired, 2 MT	13/52
AE35503	5 Way, Wired, 3 MT	13/52
AE35505	5 Way, Wired, 5 MT	12/48

# KLAUS®



**SHARP AND ELEGANT LINES!**

LIVING SPACES ARE NOW MORE  
CHARACTERISTIC AND STYLISTIC.





## Switch Specifications

Based on IEC 60669-1 standards  
PC (Original), high heat resistance and  
fire resistance class V1 (850 °C)  
Very clear and glossy surface, antistatic,  
low shrinking rate

10000 times on-off

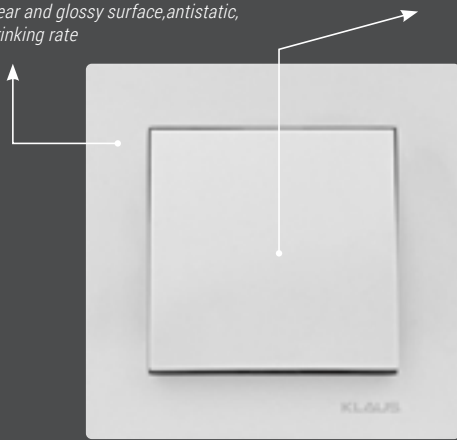

Made of PC material

Easy installation  
holes

Metal plate that is durable  
against twist and abrasion  
Zinc plated iron, NSS 96  
hours, 0.09mm thickness

Long lasting  
polycarbonate  
part

Non flammable  
interface

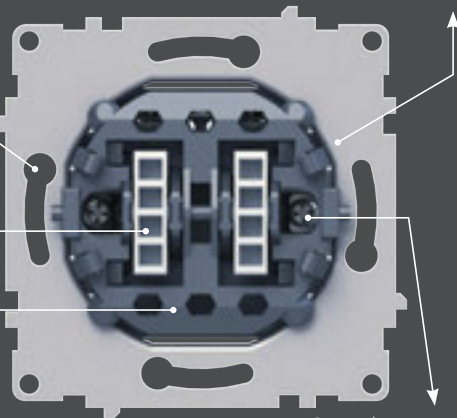

Connection screw suitable for  
flat and phillips screwdriver  
Wide screwdriver sockets

AKTEK logo carved on  
the galvanized plate

Круглые отверстия по углам  
для безопасной установки

For multiple frame  
solutions,  
aligning sockets

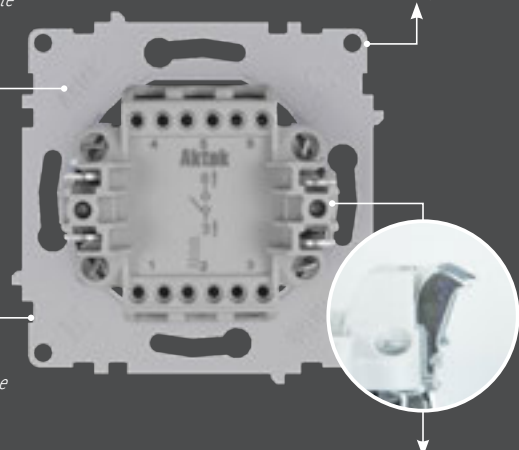

Strong and durable claws for better  
grip and quick installation

## Socket Specifications

Based on IEC 60669-1 standards  
PC (Original), high heat resistance and  
fire resistance class V1 (850 °C)  
Very clear and glossy surface, antistatic,  
low shrinking rate

10000 times on-off

Made of PC material

Made of PC material

Zinc plated iron,  
NSS 96 hours,  
0.09mm thickness

MS70, consists of 70% copper and  
certain percentages of aluminium, tin,  
lead, and zinc.  
0.04 mm thickness nickel plated with  
high radability and high conductivity

Easy installation  
holes

Connection screw suitable for  
flat and phillips screwdriver  
Wide screwdriver sockets

Non flammable interface  
PP, fire resistance class  
V1 (850°C),  
more than 150°C melt point

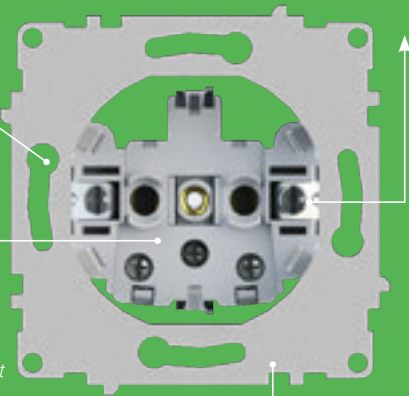

Metal plate that is durable against  
twist and abrasion  
Zinc plated iron, NSS 96 hours,  
0.09mm thickness

AKTEK logo carved on  
the galvanized plate

Round holes at the corners for  
safety installation

For multiple frame  
solutions,  
aligning sockets

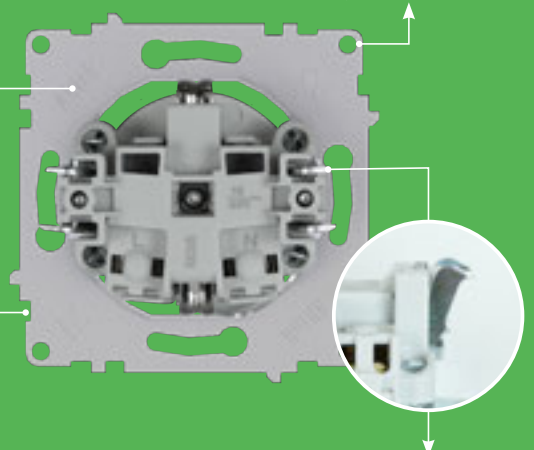

Strong and durable claws for better  
grip and quick installation





One Way Switch

**KE01101**

in box: 10 pcs. in ctn: 12\*10 pcs.



Two Way Switch

**KE01103**

in box: 10 pcs. in ctn: 12\*10 pcs.

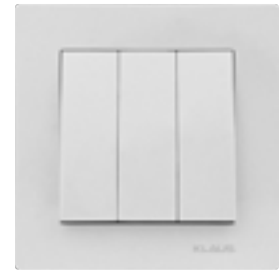

Triple Way Switch

**KE01118**

in box: 10 pcs. in ctn: 12\*10 pcs.



One Way Switch Illuminated

**KE01102**

in box: 10 pcs. in ctn: 12\*10 pcs.

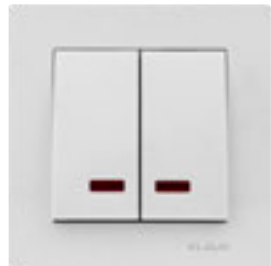

Two Way Switch Illuminated

**KE01104**

in box: 10 pcs. in ctn: 12\*10 pcs.



Dimmer Switch

**KE01114**

in box: 8 pcs. in ctn: 12\*8 pcs.



Cut Out And One Way Switch

**KE01115**

in box: 10 pcs. in ctn: 12\*10 pcs.



Cut Out One Way Switch Illuminated

**KE01116**

in box: 10 pcs. in ctn: 12\*10 pcs.



One Way Vavien Switch

**KE01119**

in box: 10 pcs. in ctn: 12\*10 pcs.



Two Way Vavien Switch

**KE01120**

in box: 10 pcs. in ctn: 12\*10 pcs.



Socket Outlet 2Pin

**KE01105**

in box: 10 pcs. in ctn: 12\*10 pcs.



Shuko Socket Outlet

**KE01107**

in box: 10 pcs. in ctn: 12\*10 pcs.



Shucko Socket Outlet W/Cover

**KE01109**

in box: 10 pcs. in ctn: 12\*10 pcs.



Socket Outlet 2Pin Double

**KE01106**

in box: 7 pcs. in ctn: 12\*7 pcs.



Double Shucko Socket Outlet

**KE01108**

in box: 6 pcs. in ctn: 12\*6 pcs.



Numeric Telephone Socket

**KE01110**

in box: 10 pcs. in ctn: 12\*10 pcs.



Data Socket Outlet

**KE01112**

in box: 10 pcs. in ctn: 12\*10 pcs.



Double Numeric Telephone Socket

**KE01111**

in box: 10 pcs. in ctn: 12\*10 pcs.



Data+Phone Socket Outlet

**KE01113**

in box: 10 pcs. in ctn: 12\*10 pcs.



Tv Antenna Socket

**KE01117**

in box: 10 pcs. in ctn: 12\*10 pcs.



Tv SAT Socket

**KE01121**

in box: 10 pcs. in ctn: 12\*10 pcs.



Single

**KE01154**

in box: 40 pcs. in ctn: 12\*40 pcs.

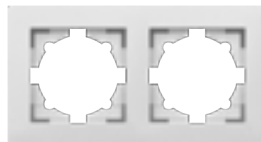

Double

**KE01150**

in box: 20 pcs. in ctn: 12\*20 pcs.



Triple

**KE01151**

in box: 14 pcs. in ctn: 12\*14 pcs.



4 Gang Frame

**KE01152**

in box: 10 pcs. in ctn: 12\*10 pcs.



5 Gang Frame

**KE01153**

in box: 10 pcs. in ctn: 12\*10 pcs.



One Way Switch

**KE01201**

in box: 10 pcs. in ctn: 12\*10 pcs.



Two Way Switch

**KE01203**

in box: 10 pcs. in ctn: 12\*10 pcs.

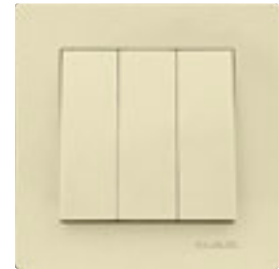

Triple Way Switch

**KE01218**

in box: 10 pcs. in ctn: 12\*10 pcs.



One Way Switch Illuminated

**KE01202**

in box: 10 pcs. in ctn: 12\*10 pcs.

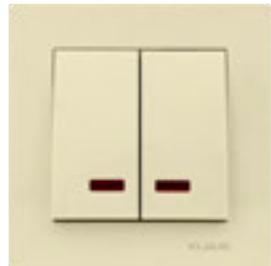

Two Way Switch Illuminated

**KE01204**

in box: 10 pcs. in ctn: 12\*10 pcs.



Dimmer Switch

**KE01214**

in box: 8 pcs. in ctn: 12\*8 pcs.



Cut Out And One Way Switch

**KE01215**

in box: 10 pcs. in ctn: 12\*10 pcs.



Cut Out One Way Switch Illuminated

**KE01216**

in box: 10 pcs. in ctn: 12\*10 pcs.



One Way Vavien Switch

**KE01219**

in box: 10 pcs. in ctn: 12\*10 pcs.



Two Way Vavien Switch

**KE01220**

in box: 10 pcs. in ctn: 12\*10 pcs.



Socket Outlet 2Pin

**KE01205**

in box: 10 pcs. in ctn: 12\*10 pcs.



Shuko Socket Outlet

**KE01207**

in box: 10 pcs. in ctn: 12\*10 pcs.





Shucko Socket Outlet W/Cover

**KE01209**

in box: 10 pcs. in ctn: 12\*10 pcs.



Socket Outlet 2Pin Double

**KE01206**

in box: 7 pcs. in ctn: 12\*7 pcs.

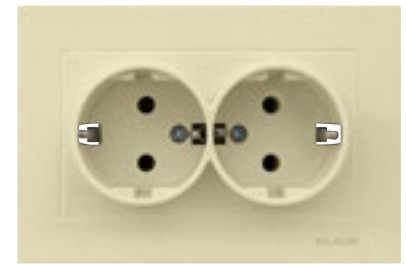

Double Shucko Socket Outlet

**KE01208**

in box: 6 pcs. in ctn: 12\*6 pcs.



Numeric Telephone Socket

**KE01210**

in box: 10 pcs. in ctn: 12\*10 pcs.



Data Socket Outlet

**KE01212**

in box: 10 pcs. in ctn: 12\*10 pcs.



Double Numeric Telephone Socket

**KE01211**

in box: 10 pcs. in ctn: 12\*10 pcs.



Data+Phone Socket Outlet

**KE01213**

in box: 10 pcs. in ctn: 12\*10 pcs.

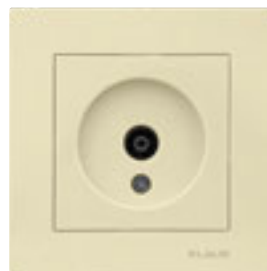

Tv Antenna Socket

**KE01217**

in box: 10 pcs. in ctn: 12\*10 pcs.

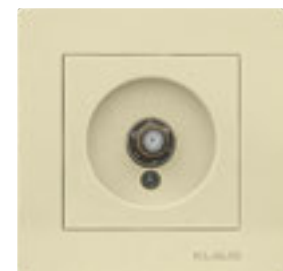

Tv SAT Socket

**KE01221**

in box: 10 pcs. in ctn: 12\*10 pcs.



Single

**KE01254**

in box: 40 pcs. in ctn: 12\*40 pcs.



Double

**KE01250**

in box: 20 pcs. in ctn: 12\*20 pcs.



Triple

**KE01251**

in box: 14 pcs. in ctn: 12\*14 pcs.



4 Gang Frame

**KE01252**

in box: 10 pcs. in ctn: 12\*10 pcs.



5 Gang Frame

**KE01253**

in box: 10 pcs. in ctn: 12\*10 pcs.



One Way Switch

**KE01701**

in box: 10 pcs. in ctn: 12\*10 pcs.



Two Way Switch

**KE01703**

in box: 10 pcs. in ctn: 12\*10 pcs.



Triple Way Switch

**KE01718**

in box: 10 pcs. in ctn: 12\*10 pcs.



One Way Switch Illuminated

**KE01702**

in box: 10 pcs. in ctn: 12\*10 pcs.



Two Way Switch Illuminated

**KE01704**

in box: 10 pcs. in ctn: 12\*10 pcs.



Dimmer Switch

**KE01714**

in box: 8 pcs. in ctn: 12\*8 pcs.



Cut Out And One Way Switch

**KE01715**

in box: 10 pcs. in ctn: 12\*10 pcs.



Cut Out One Way Switch Illuminated

**KE01716**

in box: 10 pcs. in ctn: 12\*10 pcs.



One Way Vavien Switch

**KE01719**

in box: 10 pcs. in ctn: 12\*10 pcs.



Two Way Vavien Switch

**KE01720**

in box: 10 pcs. in ctn: 12\*10 pcs.



Socket Outlet 2Pin

**KE01705**

in box: 10 pcs. in ctn: 12\*10 pcs.



Shucko Socket Outlet

**KE01707**

in box: 10 pcs. in ctn: 12\*10 pcs.



Shucko Socket Outlet W/Cover

**KE01709**

in box: 10 pcs. in ctn: 12\*10 pcs.



Socket Outlet 2Pin Double

**KE01706**

in box: 7 pcs. in ctn: 12\*7 pcs.



Double Shucko Socket Outlet

**KE01708**

in box: 6 pcs. in ctn: 12\*6 pcs.



Numeric Telephone Socket

**KE01710**

in box: 10 pcs. in ctn: 12\*10 pcs.



Data Socket Outlet

**KE01712**

in box: 10 pcs. in ctn: 12\*10 pcs.



Double Numeric Telephone Socket

**KE01711**

in box: 10 pcs. in ctn: 12\*10 pcs.



Data+Phone Socket Outlet

**KE01713**

in box: 10 pcs. in ctn: 12\*10 pcs.



Tv Antenna Socket

**KE01717**

in box: 10 pcs. in ctn: 12\*10 pcs.



Tv SAT Socket

**KE01721**

in box: 10 pcs. in ctn: 12\*10 pcs.



Single

**KE01754**

in box: 40 pcs. in ctn: 12\*40 pcs.



Double

**KE01750**

in box: 20 pcs. in ctn: 12\*20 pcs.



Triple

**KE01751**

in box: 14 pcs. in ctn: 12\*14 pcs.

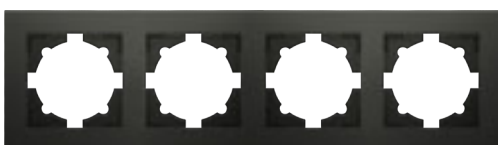

4 Gang Frame

**KE01752**

in box: 10 pcs. in ctn: 12\*10 pcs.



5 Gang Frame

**KE01753**

in box: 10 pcs. in ctn: 12\*10 pcs.



One Way Switch

**KE01401**

in box: 10 pcs. in ctn: 12\*10 pcs.

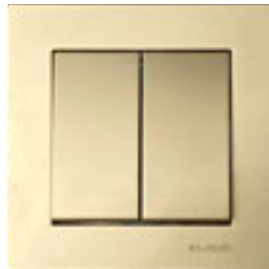

Two Way Switch

**KE01403**

in box: 10 pcs. in ctn: 12\*10 pcs.

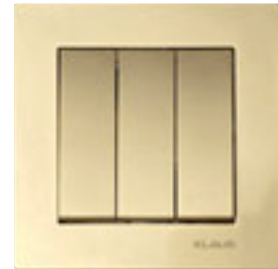

Triple Way Switch

**KE01418**

in box: 10 pcs. in ctn: 12\*10 pcs.



One Way Switch Illuminated

**KE01402**

in box: 10 pcs. in ctn: 12\*10 pcs.

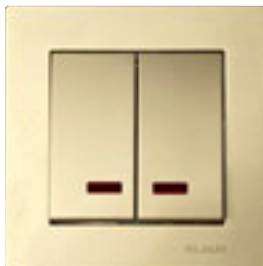

Two Way Switch Illuminated

**KE01404**

in box: 10 pcs. in ctn: 12\*10 pcs.



Dimmer Switch

**KE01414**

in box: 8 pcs. in ctn: 12\*8 pcs.



Cut Out And One Way Switch

**KE01415**

in box: 10 pcs. in ctn: 12\*10 pcs.



Cut Out One Way Switch Illuminated

**KE01416**

in box: 10 pcs. in ctn: 12\*10 pcs.



One Way Vavien Switch

**KE01419**

in box: 10 pcs. in ctn: 12\*10 pcs.

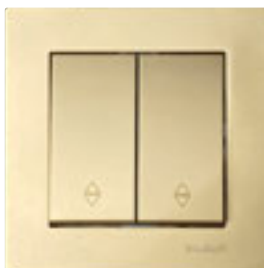

Two Way Vavien Switch

**KE01420**

in box: 10 pcs. in ctn: 12\*10 pcs.



Socket Outlet 2Pin

**KE01405**

in box: 10 pcs. in ctn: 12\*10 pcs.



Shuko Socket Outlet

**KE01407**

in box: 10 pcs. in ctn: 12\*10 pcs.





Shucko Socket Outlet W/Cover

**KE01409**

in box: 10 pcs. in ctn: 12\*10 pcs.



Socket Outlet 2Pin Double

**KE01406**

in box: 7 pcs. in ctn: 12\*7 pcs.



Double Shucko Socket Outlet

**KE01408**

in box: 6 pcs. in ctn: 12\*6 pcs.



Numeric Telephone Socket

**KE01410**

in box: 10 pcs. in ctn: 12\*10 pcs.



Data Socket Outlet

**KE01412**

in box: 10 pcs. in ctn: 12\*10 pcs.



Double Numeric Telephone Socket

**KE01411**

in box: 10 pcs. in ctn: 12\*10 pcs.



Data+Phone Socket Outlet

**KE01413**

in box: 10 pcs. in ctn: 12\*10 pcs.

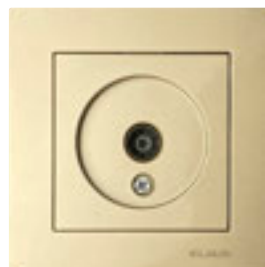

Tv Antenna Socket

**KE01417**

in box: 10 pcs. in ctn: 12\*10 pcs.



Tv SAT Socket

**KE01421**

in box: 10 pcs. in ctn: 12\*10 pcs.

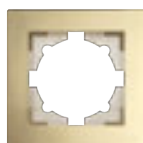

Single

**KE01454**

in box: 40 pcs. in ctn: 12\*40 pcs.

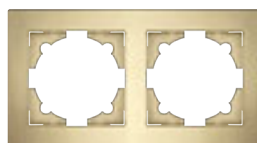

Double

**KE01450**

in box: 20 pcs. in ctn: 12\*20 pcs.

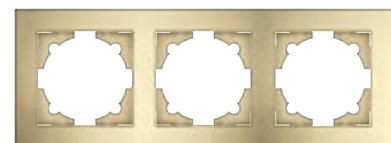

Triple

**KE01451**

in box: 14 pcs. in ctn: 12\*14 pcs.

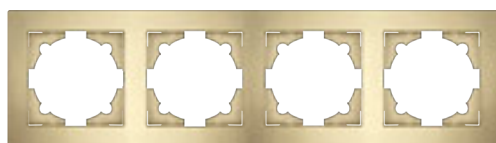

4 Gang Frame

**KE01452**

in box: 10 pcs. in ctn: 12\*10 pcs.



5 Gang Frame

**KE01453**

in box: 10 pcs. in ctn: 12\*10 pcs.



One Way Switch

**KE01301**

in box: 10 pcs. in ctn: 12\*10 pcs.



Two Way Switch

**KE01303**

in box: 10 pcs. in ctn: 12\*10 pcs.

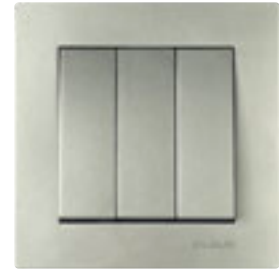

Triple Way Switch

**KE01318**

in box: 10 pcs. in ctn: 12\*10 pcs.



One Way Switch Illuminated

**KE01302**

in box: 10 pcs. in ctn: 12\*10 pcs.



Two Way Switch Illuminated

**KE01304**

in box: 10 pcs. in ctn: 12\*10 pcs.



Dimmer Switch

**KE01314**

in box: 8 pcs. in ctn: 12\*8 pcs.



Cut Out And One Way Switch

**KE01315**

in box: 10 pcs. in ctn: 12\*10 pcs.



Cut Out One Way Switch Illuminated

**KE01316**

in box: 10 pcs. in ctn: 12\*10 pcs.



One Way Vavien Switch

**KE01319**

in box: 10 pcs. in ctn: 12\*10 pcs.



Two Way Vavien Switch

**KE01320**

in box: 10 pcs. in ctn: 12\*10 pcs.



Socket Outlet 2Pin

**KE01305**

in box: 10 pcs. in ctn: 12\*10 pcs.



Shuko Socket Outlet

**KE01307**

in box: 10 pcs. in ctn: 12\*10 pcs.



Shucko Socket Outlet W/Cover

**KE01309**

in box: 10 pcs. in ctn: 12\*10 pcs.



Socket Outlet 2Pin Double

**KE01306**

in box: 7 pcs. in ctn: 12\*7 pcs.



Double Shucko Socket Outlet

**KE01308**

in box: 6 pcs. in ctn: 12\*6 pcs.



Numeric Telephone Socket

**KE01310**

in box: 10 pcs. in ctn: 12\*10 pcs.



Data Socket Outlet

**KE01312**

in box: 10 pcs. in ctn: 12\*10 pcs.



Double Numeric Telephone Socket

**KE01311**

in box: 10 pcs. in ctn: 12\*10 pcs.



Data+Phone Socket Outlet

**KE01313**

in box: 10 pcs. in ctn: 12\*10 pcs.



Tv Antenna Socket

**KE01317**

in box: 10 pcs. in ctn: 12\*10 pcs.



Tv SAT Socket

**KE01321**

in box: 10 pcs. in ctn: 12\*10 pcs.



Single

**KE01354**

in box: 40 pcs. in ctn: 12\*40 pcs.

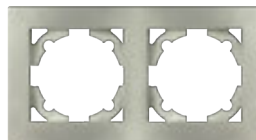

Double

**KE01350**

in box: 20 pcs. in ctn: 12\*20 pcs.



Triple

**KE01351**

in box: 14 pcs. in ctn: 12\*14 pcs.

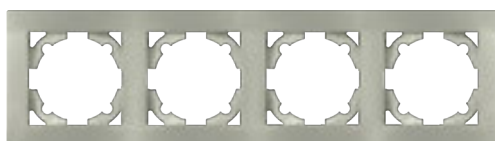

4 Gang Frame

**KE01352**

in box: 10 pcs. in ctn: 12\*10 pcs.

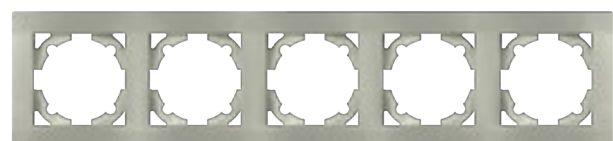

5 Gang Frame

**KE01353**

in box: 10 pcs. in ctn: 12\*10 pcs.



One Way Switch

**KE01501**

in box: 10 pcs. in ctn: 12\*10 pcs.



Two Way Switch

**KE01503**

in box: 10 pcs. in ctn: 12\*10 pcs.



Triple Way Switch

**KE01518**

in box: 10 pcs. in ctn: 12\*10 pcs.



One Way Switch Illuminated

**KE01502**

in box: 10 pcs. in ctn: 12\*10 pcs.



Two Way Switch Illuminated

**KE01504**

in box: 10 pcs. in ctn: 12\*10 pcs.



Dimmer Switch

**KE01514**

in box: 8 pcs. in ctn: 12\*8 pcs.



Cut Out And One Way Switch

**KE01515**

in box: 10 pcs. in ctn: 12\*10 pcs.



Cut Out One Way Switch Illuminated

**KE01516**

in box: 10 pcs. in ctn: 12\*10 pcs.



One Way Vavien Switch

**KE01519**

in box: 10 pcs. in ctn: 12\*10 pcs.



Two Way Vavien Switch

**KE01520**

in box: 10 pcs. in ctn: 12\*10 pcs.



Socket Outlet 2Pin

**KE01505**

in box: 10 pcs. in ctn: 12\*10 pcs.

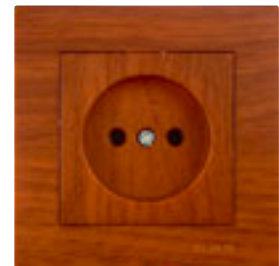

Shuko Socket Outlet

**KE01507**

in box: 10 pcs. in ctn: 12\*10 pcs.



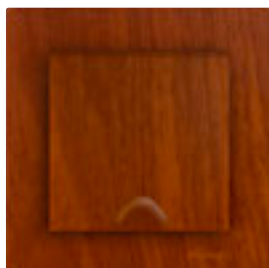

Shucko Socket Outlet W/Cover

**KE01509**

in box: 10 pcs. in ctn: 12\*10 pcs.



Socket Outlet 2Pin Double

**KE01506**

in box: 7 pcs. in ctn: 12\*7 pcs.



Double Shucko Socket Outlet

**KE01508**

in box: 6 pcs. in ctn: 12\*6 pcs.



Numeric Telephone Socket

**KE01510**

in box: 10 pcs. in ctn: 12\*10 pcs.



Data Socket Outlet

**KE01512**

in box: 10 pcs. in ctn: 12\*10 pcs.



Double Numeric Telephone Socket

**KE01511**

in box: 10 pcs. in ctn: 12\*10 pcs.



Data+Phone Socket Outlet

**KE01513**

in box: 10 pcs. in ctn: 12\*10 pcs.



Tv Antenna Socket

**KE01517**

in box: 10 pcs. in ctn: 12\*10 pcs.



Tv SAT Socket

**KE01521**

in box: 10 pcs. in ctn: 12\*10 pcs.



Single

**KE01554**

in box: 40 pcs. in ctn: 12\*40 pcs.



Double

**KE01550**

in box: 20 pcs. in ctn: 12\*20 pcs.



Triple

**KE01551**

in box: 14 pcs. in ctn: 12\*14 pcs.

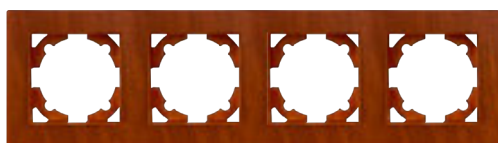

4 Gang Frame

**KE01552**

in box: 10 pcs. in ctn: 12\*10 pcs.





5 Gang Frame

**KE01553**

in box: 10 pcs. in ctn: 12\*10 pcs.

**SHARP AND ELEGANT LINES!**



 klausled  klausled

[www.klauselectric.com](http://www.klauselectric.com)



## About ANURA

ANURA Electric, is the brand founded in 2012 by Turkish capital, consisting of switch and socket models mainly. The brand also provides with contribution box, extension sockets, and other accessories.

ANURA electric who has got a wide distribution channels in many countries aims at reaching large mass and being on top in terms of offering the most competitive prices.

[www.anuraelectric.com](http://www.anuraelectric.com)

## Table of Content / Содержание



White  
Cream  
Silver  
Golden  
Wooden



White  
Cream  
Silver  
Golden



White switch - socket  
Ip54 switch - socket

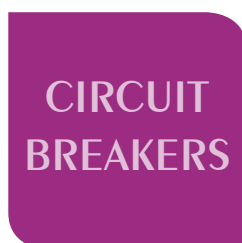

Circuit Breakers  
Accessories



## Switch Specifications

Based on IEC 60669-1 standards

PC (Original), high heat resistance and fire resistance class V1 (850 °C)  
Very clear and glossy surface, antistatic, low shrinking rate

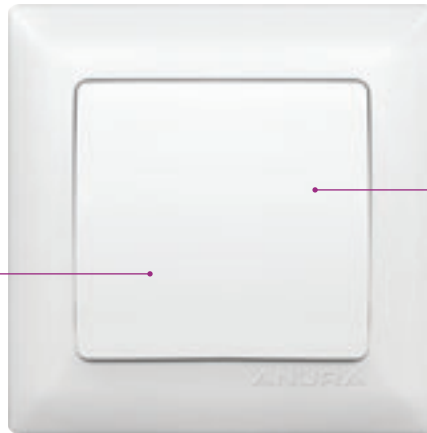

Made of PC material

5000 times on-off

Easy installation holes

Long lasting polycarbonate part

Non flammable interface

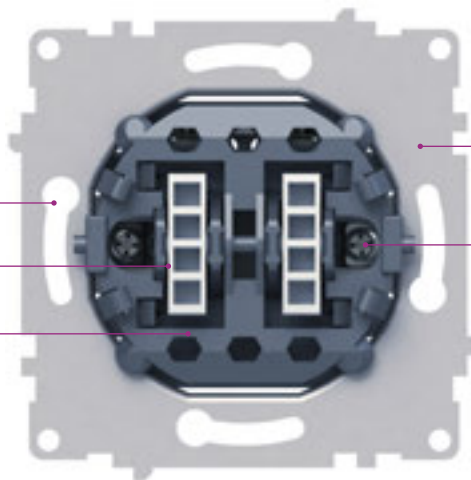

Metal plate that is durable against twist and abrasion  
Zinc plated iron, NSS 96 hours, 0.09mm thickness

Connection screw suitable for flat and phillips screwdriver  
Wide screwdriver sockets

ANURA logo carved on the galvanized plate

For multiple frame solutions, aligning sockets

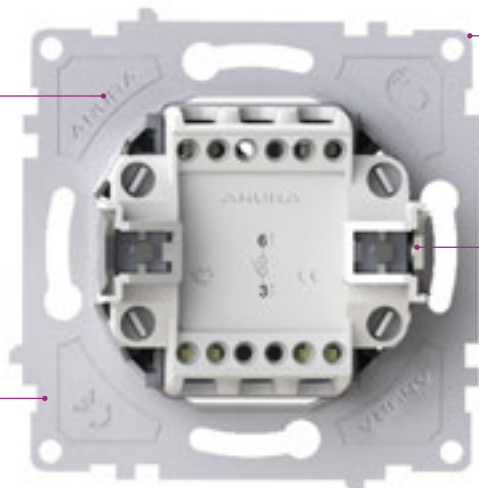

Round holes at the corners for safety installation

Long lasting claws for safe and fast installation

## Socket Specifications

Based on IEC 60669-1 standards

PC (Original), high heat resistance and fire resistance class V1(850 °C)  
Very clear and glossy surface, antistatic, low shrinking rate

MS70, consists of 70% copper and certain percentages of aluminium, tin, lead, and zinc.  
0.04 mm thickness nickel plated with high durability and high conductivity



Made of PC material

Zinc plated iron  $\Phi 3\text{mm}$ , NSS 36 hours

5000 times plug in-out

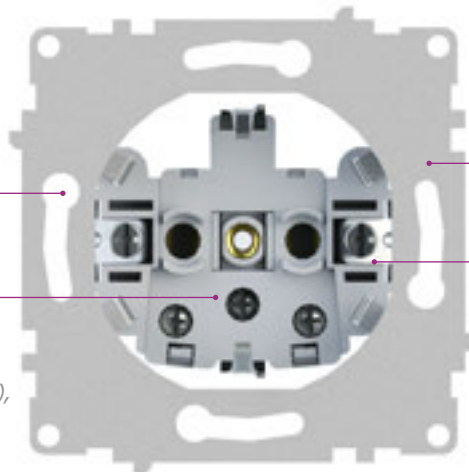

Easy installation holes

Non flammable interface  
PP, fire resistance class V1(850°C), more than 150°C melt point

Metal plate that is durable against twist and abrasion  
Zinc plated iron, NSS 96 hours, 0.65 mm thickness

Connection screw suitable for flat and phillips screwdriver  
Wide screwdriver sockets

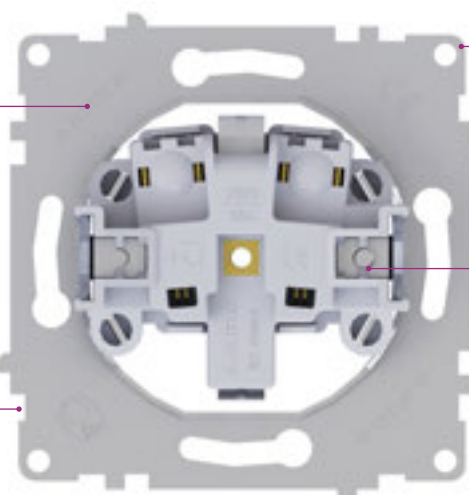

ANURA logo carved on the galvanized plate

For multiple frame solutions, aligning sockets

Round holes at the corners for safety installation

Long lasting claws for safe and fast installation



**ANURA**<sup>®</sup>  
ELECTRIC EQUIPMENTS

**MARMARIS SERIES**



*Fast and easy  
installation.  
Long life  
Elegant Design*

## Marmaris white series

**One Way Switch****AE01101**

in box: 10 pcs. in ctn: 12\*10 pcs.

**Two Way Switch****AE01103**

in box: 10 pcs. in ctn: 12\*10 pcs.

**Triple Way Switch****AE01118**

in box: 10 pcs. in ctn: 12\*10 pcs.

**One Way Switch Illuminated****AE01102**

in box: 10 pcs. in ctn: 12\*10 pcs.

**Two Way Switch Illuminated****AE01104**

in box: 10 pcs. in ctn: 12\*10 pcs.

**Dimmer Switch****AE01114**

in box: 8 pcs. in ctn: 12\*8 pcs.

**Cut Out And One Way Switch****AE01115**

in box: 10 pcs. in ctn: 12\*10 pcs.

**Cut Out One Way Switch Illuminated****AE01116**

in box: 10 pcs. in ctn: 12\*10 pcs.

**One Way Vavien Switch****AE01119**

in box: 10 pcs. in ctn: 12\*10 pcs.

**Two Way Vavien Switch****AE01120**

in box: 10 pcs. in ctn: 12\*10 pcs.



## Marmaris white series



Socket Outlet 2Pin

**AE01105**  
**AE01105P (Ceramic)**  
in box: 10 pcs. in ctn: 12\*10 pcs.



Shucko Socket Outlet

**AE01107**  
**AE01107P (Ceramic)**  
in box: 10 pcs. in ctn: 12\*10 pcs.



Shucko Socket Outlet With USB

**AE01107U**  
in box: 10 pcs. in ctn: 12\*10 pcs.



Shucko Socket Outlet W/Cover

**AE01109**  
**AE01109P (Ceramic)**  
in box: 10 pcs. in ctn: 12\*10 pcs.



Socket Outlet 2Pin Double

**AE01106**  
**AE01106P (Ceramic)**  
in box: 7 pcs. in ctn: 12\*7 pcs.



Double Shucko Socket Outlet

**AE01108**  
**AE01108P (Ceramic)**  
in box: 6 pcs. in ctn: 12\*6 pcs.



Numeric Telephone Socket

**AE01110**  
in box: 10 pcs. in ctn: 12\*10 pcs.



Data Socket Outlet

**AE01112**  
in box: 10 pcs. in ctn: 12\*10 pcs.



Double Numeric Telephone Socket

**AE01111**  
in box: 10 pcs. in ctn: 12\*10 pcs.



Data+Phone Socket Outlet

**AE01113**  
in box: 10 pcs. in ctn: 12\*10 pcs.



Tv Antenna Socket

**AE01117**  
in box: 10 pcs. in ctn: 12\*10 pcs.



Tv SAT Socket

**AE01121**  
in box: 10 pcs. in ctn: 12\*10 pcs.

## Marmaris white series

**One Way Switch****AE01101W**

in box: 10 pcs. in ctn: 12\*10 pcs.

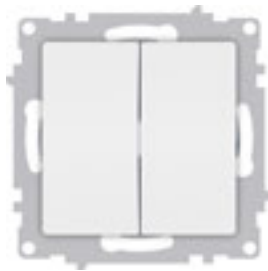
**Two Way Switch****AE01103W**

in box: 10 pcs. in ctn: 12\*10 pcs.

**Triple Way Switch****AE01118W**

in box: 10 pcs. in ctn: 12\*10 pcs.

**One Way Switch Illuminated****AE01102W**

in box: 10 pcs. in ctn: 12\*10 pcs.

**Two Way Switch Illuminated****AE01104W**

in box: 10 pcs. in ctn: 12\*10 pcs.

**Dimmer Switch****AE01114W**

in box: 8 pcs. in ctn: 12\*8 pcs.

**Cut Out And One Way Switch****AE01115W**

in box: 10 pcs. in ctn: 12\*10 pcs.

**Cut Out One Way Switch Illuminated****AE01116W**

in box: 10 pcs. in ctn: 12\*10 pcs.

**One Way Vavien Switch****AE01119W**

in box: 10 pcs. in ctn: 12\*10 pcs.

**Two Way Vavien Switch****AE01120W**

in box: 10 pcs. in ctn: 12\*10 pcs.

## Marmaris white series



Socket Outlet 2Pin

**AE01105W**

in box: 10 pcs. in ctn: 12\*10 pcs.



Shucko Socket Outlet

**AE01107W**

in box: 10 pcs. in ctn: 12\*10 pcs.



Shucko Socket Outlet With USB

**AE01107WU**

in box: 10 pcs. in ctn: 12\*10 pcs.



Shucko Socket Outlet W/Cover

**AE01109W**

in box: 10 pcs. in ctn: 12\*10 pcs.



Numeric Telephone Socket

**AE01110W**

in box: 10 pcs. in ctn: 12\*10 pcs.



Double Numeric Telephone Socket

**AE01111W**

in box: 10 pcs. in ctn: 12\*10 pcs.



Data Socket Outlet

**AE01112W**

in box: 10 pcs. in ctn: 12\*10 pcs.



Data+Phone Socket Outlet

**AE01113W**

in box: 10 pcs. in ctn: 12\*10 pcs.



Tv Antenna Socket

**AE01117W**

in box: 10 pcs. in ctn: 12\*10 pcs.



Tv SAT Socket

**AE01121W**

in box: 10 pcs. in ctn: 12\*10 pcs.

## Marmaris cream series



**One Way Switch**

**AE01201**

in box: 10 pcs. in ctn: 12\*10 pcs.



**Two Way Switch**

**AE01203**

in box: 10 pcs. in ctn: 12\*10 pcs.



**Triple Way Switch**

**AE01218**

in box: 10 pcs. in ctn: 12\*10 pcs.



**One Way Switch Illuminated**

**AE01202**

in box: 10 pcs. in ctn: 12\*10 pcs.



**Two Way Switch Illuminated**

**AE01204**

in box: 10 pcs. in ctn: 12\*10 pcs.



**Dimmer Switch**

**AE01214**

in box: 8 pcs. in ctn: 12\*8 pcs.



**Cut Out And One Way Switch**

**AE01215**

in box: 10 pcs. in ctn: 12\*10 pcs.



**Cut Out One Way Switch Illuminated**

**AE01216**

in box: 10 pcs. in ctn: 12\*10 pcs.



**One Way Vavien Switch**

**AE01219**

in box: 10 pcs. in ctn: 12\*10 pcs.



**Two Way Vavien Switch**

**AE01220**

in box: 10 pcs. in ctn: 12\*10 pcs.



## Marmaris cream series



Socket Outlet 2Pin

**AE01205**  
**AE01205P (Ceramic)**  
in box: 10 pcs. in ctn: 12\*10 pcs.



Shucko Socket Outlet

**AE01207**  
**AE01207P (Ceramic)**  
in box: 10 pcs. in ctn: 12\*10 pcs.



Shucko Socket Outlet With USB

**AE01207U**  
in box: 10 pcs. in ctn: 12\*10 pcs.



Shucko Socket Outlet W/Cover

**AE01209**  
**AE01209P (Ceramic)**  
in box: 10 pcs. in ctn: 12\*10 pcs.



Socket Outlet 2Pin Double

**AE01206**  
**AE01206P (Ceramic)**  
in box: 7 pcs. in ctn: 12\*7 pcs.



Double Shucko Socket Outlet

**AE01208**  
**AE01208P (Ceramic)**  
in box: 6 pcs. in ctn: 12\*6 pcs.



Numeric Telephone Socket

**AE01210**  
in box: 10 pcs. in ctn: 12\*10 pcs.



Data Socket Outlet

**AE01212**  
in box: 10 pcs. in ctn: 12\*10 pcs.



Double Numeric Telephone Socket

**AE01211**  
in box: 10 pcs. in ctn: 12\*10 pcs.



Data+Phone Socket Outlet

**AE01213**  
in box: 10 pcs. in ctn: 12\*10 pcs.



Tv Antenna Socket

**AE01217**  
in box: 10 pcs. in ctn: 12\*10 pcs.



Tv SAT Socket

**AE01221**  
in box: 10 pcs. in ctn: 12\*10 pcs.

## Marmaris cream series

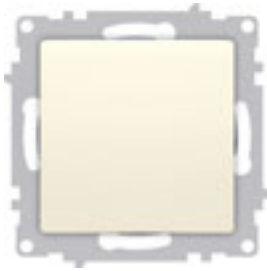

**One Way Switch**

**AE01201W**

in box: 10 pcs. in ctn: 12\*10 pcs.

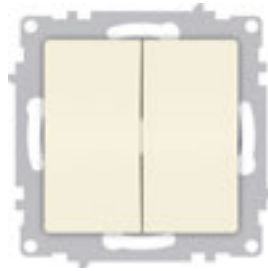

**Two Way Switch**

**AE01203W**

in box: 10 pcs. in ctn: 12\*10 pcs.

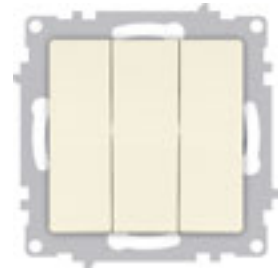

**Triple Way Switch**

**AE01218W**

in box: 10 pcs. in ctn: 12\*10 pcs.



**One Way Switch Illuminated**

**AE01202W**

in box: 10 pcs. in ctn: 12\*10 pcs.

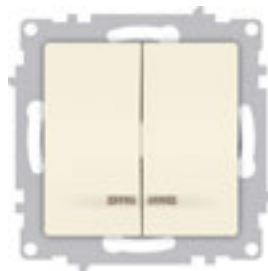

**Two Way Switch Illuminated**

**AE01204W**

in box: 10 pcs. in ctn: 12\*10 pcs.



**Dimmer Switch**

**AE01214W**

in box: 8 pcs. in ctn: 12\*8 pcs.



**Cut Out And One Way Switch**

**AE01215W**

in box: 10 pcs. in ctn: 12\*10 pcs.



**Cut Out One Way Switch Illuminated**

**AE01216W**

in box: 10 pcs. in ctn: 12\*10 pcs.



**One Way Vavien Switch**

**AE01219W**

in box: 10 pcs. in ctn: 12\*10 pcs.



**Two Way Vavien Switch**

**AE01220W**

in box: 10 pcs. in ctn: 12\*10 pcs.

## Marmaris cream series



Socket Outlet 2Pin

**AE01205W**

in box: 10 pcs. in ctn: 12\*10 pcs.



Shucko Socket Outlet

**AE01207W**

in box: 10 pcs. in ctn: 12\*10 pcs.



Shucko Socket Outlet With USB

**AE01207WU**

in box: 10 pcs. in ctn: 12\*10 pcs.

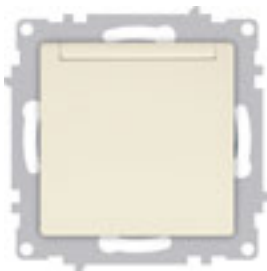

Shucko Socket Outlet W/Cover

**AE01209W**

in box: 10 pcs. in ctn: 12\*10 pcs.



Numeric Telephone Socket

**AE01210W**

in box: 10 pcs. in ctn: 12\*10 pcs.



Double Numeric Telephone Socket

**AE01211W**

in box: 10 pcs. in ctn: 12\*10 pcs.



Data Socket Outlet

**AE01212W**

in box: 10 pcs. in ctn: 12\*10 pcs.



Data+Phone Socket Outlet

**AE01213W**

in box: 10 pcs. in ctn: 12\*10 pcs.



Tv Antenna Socket

**AE01217W**

in box: 10 pcs. in ctn: 12\*10 pcs.



Tv SAT Socket

**AE01221W**

in box: 10 pcs. in ctn: 12\*10 pcs.

## Marmaris aluminium series



**One Way Switch**

**AE01301**

in box: 10 pcs. in ctn: 12\*10 pcs.



**Two Way Switch**

**AE01303**

in box: 10 pcs. in ctn: 12\*10 pcs.

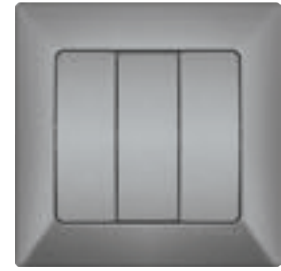

**Triple Way Switch**

**AE01318**

in box: 10 pcs. in ctn: 12\*10 pcs.



**One Way Switch Illuminated**

**AE01302**

in box: 10 pcs. in ctn: 12\*10 pcs.

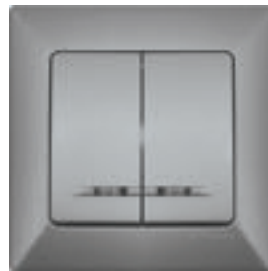

**Two Way Switch Illuminated**

**AE01304**

in box: 10 pcs. in ctn: 12\*10 pcs.



**Dimmer Switch**

**AE01314**

in box: 8 pcs. in ctn: 12\*8 pcs.



**Cut Out And One Way Switch**

**AE01315**

in box: 10 pcs. in ctn: 12\*10 pcs.



**Cut Out One Way Switch Illuminated**

**AE01316**

in box: 10 pcs. in ctn: 12\*10 pcs.



**One Way Vavien Switch**

**AE01319**

in box: 10 pcs. in ctn: 12\*10 pcs.



**Two Way Vavien Switch**

**AE01320**

in box: 10 pcs. in ctn: 12\*10 pcs.



## Marmaris aluminium series



Socket Outlet 2Pin

**AE01305**

in box: 10 pcs. in ctn: 12\*10 pcs.



Shucko Socket Outlet

**AE01307**

in box: 10 pcs. in ctn: 12\*10 pcs.



Shucko Socket Outlet With USB

**AE01307U**

in box: 10 pcs. in ctn: 12\*10 pcs.



Shucko Socket Outlet W/Cover

**AE01309**

in box: 10 pcs. in ctn: 12\*10 pcs.



Socket Outlet 2Pin Double

**AE01306**

in box: 7 pcs. in ctn: 12\*7 pcs.



Double Shucko Socket Outlet

**AE01308**

in box: 6 pcs. in ctn: 12\*6 pcs.



Numeric Telephone Socket

**AE01310**

in box: 10 pcs. in ctn: 12\*10 pcs.



Data Socket Outlet

**AE01312**

in box: 10 pcs. in ctn: 12\*10 pcs.



Double Numeric Telephone Socket

**AE01311**

in box: 10 pcs. in ctn: 12\*10 pcs.



Data+Phone Socket Outlet

**AE01313**

in box: 10 pcs. in ctn: 12\*10 pcs.



Tv Antenna Socket

**AE01317**

in box: 10 pcs. in ctn: 12\*10 pcs.



Tv SAT Socket

**AE01321**

in box: 10 pcs. in ctn: 12\*10 pcs.

## Marmaris gold series



**One Way Switch**

**AE01401**

in box: 10 pcs. in ctn: 12\*10 pcs.



**Two Way Switch**

**AE01403**

in box: 10 pcs. in ctn: 12\*10 pcs.



**Triple Way Switch**

**AE01418**

in box: 10 pcs. in ctn: 12\*10 pcs.



**One Way Switch Illuminated**

**AE01402**

in box: 10 pcs. in ctn: 12\*10 pcs.

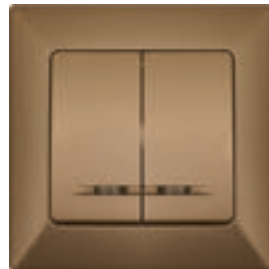

**Two Way Switch Illuminated**

**AE01404**

in box: 10 pcs. in ctn: 12\*10 pcs.



**Dimmer Switch**

**AE01414**

in box: 8 pcs. in ctn: 12\*8 pcs.



**Cut Out And One Way Switch**

**AE01415**

in box: 10 pcs. in ctn: 12\*10 pcs.



**Cut Out One Way Switch Illuminated**

**AE01416**

in box: 10 pcs. in ctn: 12\*10 pcs.



**One Way Vavien Switch**

**AE01419**

in box: 10 pcs. in ctn: 12\*10 pcs.



**Two Way Vavien Switch**

**AE01420**

in box: 10 pcs. in ctn: 12\*10 pcs.

## Marmaris gold series



Socket Outlet 2Pin

**AE01405**

in box: 10 pcs. in ctn: 12\*10 pcs.



Shucko Socket Outlet

**AE01407**

in box: 10 pcs. in ctn: 12\*10 pcs.



Shucko Socket Outlet With USB

**AE01407U**

in box: 10 pcs. in ctn: 12\*10 pcs.



Shucko Socket Outlet W/Cover

**AE01409**

in box: 10 pcs. in ctn: 12\*10 pcs.



Socket Outlet 2Pin Double

**AE01406**

in box: 7 pcs. in ctn: 12\*7 pcs.



Double Shucko Socket Outlet

**AE01408**

in box: 6 pcs. in ctn: 12\*6 pcs.



Numeric Telephone Socket

**AE01410**

in box: 10 pcs. in ctn: 12\*10 pcs.



Data Socket Outlet

**AE01412**

in box: 10 pcs. in ctn: 12\*10 pcs.



Double Numeric Telephone Socket

**AE01411**

in box: 10 pcs. in ctn: 12\*10 pcs.



Data+Phone Socket Outlet

**AE01413**

in box: 10 pcs. in ctn: 12\*10 pcs.



Tv Antenna Socket

**AE01417**

in box: 10 pcs. in ctn: 12\*10 pcs.



Tv SAT Socket

**AE01421**

in box: 10 pcs. in ctn: 12\*10 pcs.

## Marmaris wooden series



**One Way Switch**

**AE01501**

in box: 10 pcs. in ctn: 12\*10 pcs.



**Two Way Switch**

**AE01503**

in box: 10 pcs. in ctn: 12\*10 pcs.



**Triple Way Switch**

**AE01518**

in box: 10 pcs. in ctn: 12\*10 pcs.



**One Way Switch Illuminated**

**AE01502**

in box: 10 pcs. in ctn: 12\*10 pcs.



**Two Way Switch Illuminated**

**AE01504**

in box: 10 pcs. in ctn: 12\*10 pcs.



**Dimmer Switch**

**AE01514**

in box: 8 pcs. in ctn: 12\*8 pcs.



**Cut Out And One Way Switch**

**AE01515**

in box: 10 pcs. in ctn: 12\*10 pcs.



**Cut Out One Way Switch Illuminated**

**AE01516**

in box: 10 pcs. in ctn: 12\*10 pcs.



**One Way Vavien Switch**

**AE01519**

in box: 10 pcs. in ctn: 12\*10 pcs.



**Two Way Vavien Switch**

**AE01520**

in box: 10 pcs. in ctn: 12\*10 pcs.



## Marmaris wooden series



Socket Outlet 2Pin

**AE01505**

in box: 10 pcs. in ctn: 12\*10 pcs.



Shucko Socket Outlet

**AE01507**

in box: 10 pcs. in ctn: 12\*10 pcs.



Shucko Socket Outlet With USB

**AE01507U**

in box: 10 pcs. in ctn: 12\*10 pcs.



Shucko Socket Outlet W/Cover

**AE01509**

in box: 10 pcs. in ctn: 12\*10 pcs.



Socket Outlet 2Pin Double

**AE01506**

in box: 7 pcs. in ctn: 12\*7 pcs.



Double Shucko Socket Outlet

**AE01508**

in box: 6 pcs. in ctn: 12\*6 pcs.



Numeric Telephone Socket

**AE01510**

in box: 10 pcs. in ctn: 12\*10 pcs.



Data Socket Outlet

**AE01512**

in box: 10 pcs. in ctn: 12\*10 pcs.



Double Numeric Telephone Socket

**AE01511**

in box: 10 pcs. in ctn: 12\*10 pcs.



Data+Phone Socket Outlet

**AE01513**

in box: 10 pcs. in ctn: 12\*10 pcs.

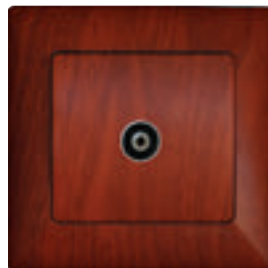

Tv Antenna Socket

**AE01517**

in box: 10 pcs. in ctn: 12\*10 pcs.

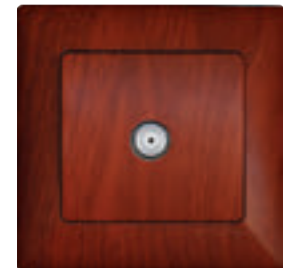

Tv SAT Socket

**AE01521**

in box: 10 pcs. in ctn: 12\*10 pcs.

## Marmaris series frames



**AE01154**  
Single  
12 x 40 Pcs.



**AE01150**  
Double  
12 x 20 Pcs.



**AE01151**  
Triple  
12 x 15 Pcs.



**AE01152**  
4 Gang Frame  
12 x 12 Pcs.



**AE01153**  
5 Gang Frame  
12 x 10 Pcs.



**AE01254**  
Single  
12 x 40 Pcs.



**AE01250**  
Double  
12 x 20 Pcs.



**AE01251**  
Triple  
12 x 15 Pcs.



**AE01252**  
4 Gang Frame  
12 x 12 Pcs.



**AE01253**  
5 Gang Frame  
12 x 10 Pcs.

## Marmaris series frames



**AE01350**  
Double  
12 x 20 Pcs.

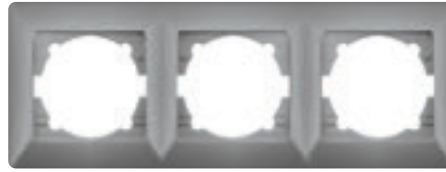

**AE01351**  
Triple  
12 x 15 Pcs.



**AE01352**  
4 Gang Frame  
12 x 12 Pcs.

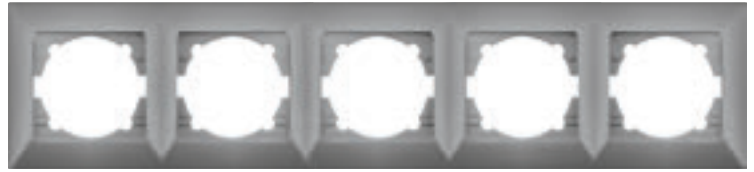

**AE01353**  
5 Gang Frame  
12 x 10 Pcs.



**AE01450**  
Double  
12 x 20 Pcs.



**AE01451**  
Triple  
12 x 15 Pcs.

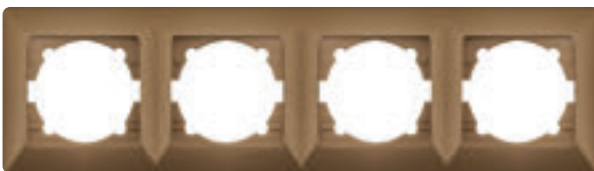

**AE01452**  
4 Gang Frame  
12 x 12 Pcs.



**AE01453**  
5 Gang Frame  
12 x 10 Pcs.



**AE01550**  
Double  
12 x 20 Pcs.



**AE01551**  
Triple  
12 x 15 Pcs.



**AE01552**  
4 Gang Frame  
12 x 12 Pcs.



**AE01553**  
5 Gang Frame  
12 x 10 Pcs.

**ANURA**<sup>®</sup>  
ELECTRIC EQUIPMENTS

**ANAMUR SERIES**



*Fast and easy  
installation.  
Long life  
Elegant Design*

[www.anuraelectric.com](http://www.anuraelectric.com)



## Anamur white series



**One Way Switch**

**AE02101**

in box: 10 pcs. in ctn: 12\*10 pcs.



**Two Way Switch**

**AE02103**

in box: 10 pcs. in ctn: 12\*10 pcs.



**Triple Way Switch**

**AE02118**

in box: 10 pcs. in ctn: 12\*10 pcs.



**One Way Switch Illuminated**

**AE02102**

in box: 10 pcs. in ctn: 12\*10 pcs.



**Two Way Switch Illuminated**

**AE02104**

in box: 10 pcs. in ctn: 12\*10 pcs.



**Dimmer Switch**

**AE02114**

in box: 8 pcs. in ctn: 12\*8 pcs.



**Cut Out And One Way Switch**

**AE02115**

in box: 10 pcs. in ctn: 12\*10 pcs.



**Cut Out One Way Switch Illuminated**

**AE02116**

in box: 10 pcs. in ctn: 12\*10 pcs.



**One Way Vavien Switch**

**AE02119**

in box: 10 pcs. in ctn: 12\*10 pcs.



**Two Way Vavien Switch**

**AE02120**

in box: 10 pcs. in ctn: 12\*10 pcs.

## Anamur white series



**Socket Outlet 2Pin**

**AE02105**

in box: 10 pcs. in ctn: 12\*10 pcs.



**Shucko Socket Outlet**

**AE02107**

in box: 10 pcs. in ctn: 12\*10 pcs.



**Shucko Socket Outlet W/Cover**

**AE02109**

in box: 10 pcs. in ctn: 12\*10 pcs.



**Socket Outlet 2Pin Double**

**AE02106**

in box: 7 pcs. in ctn: 12\*7 pcs.



**Double Shucko Socket Outlet**

**AE02108**

in box: 6 pcs. in ctn: 12\*6 pcs.



**Numeric Telephone Socket**

**AE02110**

in box: 10 pcs. in ctn: 12\*10 pcs.



**Data Socket Outlet**

**AE02112**

in box: 10 pcs. in ctn: 12\*10 pcs.



**Double Numeric Telephone Socket**

**AE02111**

in box: 10 pcs. in ctn: 12\*10 pcs.



**Data+Phone Socket Outlet**

**AE02113**

in box: 10 pcs. in ctn: 12\*10 pcs.



**Tv Antenna Socket**

**AE02117**

in box: 10 pcs. in ctn: 12\*10 pcs.



**Tv SAT Socket**

**AE02121**

in box: 10 pcs. in ctn: 12\*10 pcs.

## Anamur cream series



**One Way Switch**

**AE02201**

in box: 10 pcs. in ctn: 12\*10 pcs.



**Two Way Switch**

**AE02203**

in box: 10 pcs. in ctn: 12\*10 pcs.



**Triple Way Switch**

**AE02218**

in box: 10 pcs. in ctn: 12\*10 pcs.



**One Way Switch Illuminated**

**AE02202**

in box: 10 pcs. in ctn: 12\*10 pcs.



**Two Way Switch Illuminated**

**AE02204**

in box: 10 pcs. in ctn: 12\*10 pcs.



**Dimmer Switch**

**AE02214**

in box: 8 pcs. in ctn: 12\*8 pcs.



**Cut Out And One Way Switch**

**AE02215**

in box: 10 pcs. in ctn: 12\*10 pcs.



**Cut Out One Way Switch Illuminated**

**AE02216**

in box: 10 pcs. in ctn: 12\*10 pcs.



**One Way Vavien Switch**

**AE02219**

in box: 10 pcs. in ctn: 12\*10 pcs.



**TWO Way Vavien Switch**

**AE02220**

in box: 10 pcs. in ctn: 12\*10 pcs.

## Anamur cream series

**Socket Outlet 2Pin****AE02205**

in box: 10 pcs. in ctn: 12\*10 pcs.

**Shucko Socket Outlet****AE02207**

in box: 10 pcs. in ctn: 12\*10 pcs.

**Shucko Socket Outlet W/Cover****AE02209**

in box: 10 pcs. in ctn: 12\*10 pcs.

**Socket Outlet 2Pin Double****AE02206**

in box: 7 pcs. in ctn: 12\*7 pcs.

**Double Shucko Socket Outlet****AE02208**

in box: 6 pcs. in ctn: 12\*6 pcs.

**Numeric Telephone Socket****AE02210**

in box: 10 pcs. in ctn: 12\*10 pcs.

**Data Socket Outlet****AE02212**

in box: 10 pcs. in ctn: 12\*10 pcs.

**Double Numeric Telephone Socket****AE02211**

in box: 10 pcs. in ctn: 12\*10 pcs.

**Data+Phone Socket Outlet****AE02213**

in box: 10 pcs. in ctn: 12\*10 pcs.

**Tv Antenna Socket****AE02217**

in box: 10 pcs. in ctn: 12\*10 pcs.

**Tv SAT Socket****AE02221**

in box: 10 pcs. in ctn: 12\*10 pcs.



## Anamur silver series



**One Way Switch**

**AE02301**

in box: 10 pcs. in ctn: 12\*10 pcs.



**Two Way Switch**

**AE02303**

in box: 10 pcs. in ctn: 12\*10 pcs.



**Triple Way Switch**

**AE02318**

in box: 10 pcs. in ctn: 12\*10 pcs.



**One Way Switch Illuminated**

**AE02302**

in box: 10 pcs. in ctn: 12\*10 pcs.



**Two Way Switch Illuminated**

**AE02304**

in box: 10 pcs. in ctn: 12\*10 pcs.



**Dimmer Switch**

**AE02314**

in box: 8 pcs. in ctn: 12\*8 pcs.



**Cut Out And One Way Switch**

**AE02315**

in box: 10 pcs. in ctn: 12\*10 pcs.



**Cut Out One Way Switch Illuminated**

**AE02316**

in box: 10 pcs. in ctn: 12\*10 pcs.



**One Way Vavien Switch**

**AE02319**

in box: 10 pcs. in ctn: 12\*10 pcs.



**TWO Way Vavien Switch**

**AE02120**

in box: 10 pcs. in ctn: 12\*10 pcs.

## Anamur silver series

**Socket Outlet 2Pin****AE02305**

in box: 10 pcs. in ctn: 12\*10 pcs.

**Shucko Socket Outlet****AE02307**

in box: 10 pcs. in ctn: 12\*10 pcs.

**Shucko Socket Outlet W/Cover****AE02309**

in box: 10 pcs. in ctn: 12\*10 pcs.

**Socket Outlet 2Pin Double****AE02306**

in box: 7 pcs. in ctn: 12\*7 pcs.

**Double Shucko Socket Outlet****AE02308**

in box: 6 pcs. in ctn: 12\*6 pcs.

**Numeric Telephone Socket****AE02310**

in box: 10 pcs. in ctn: 12\*10 pcs.

**Data Socket Outlet****AE02312**

in box: 10 pcs. in ctn: 12\*10 pcs.

**Double Numeric Telephone Socket****AE02311**

in box: 10 pcs. in ctn: 12\*10 pcs.

**Data+Phone Socket Outlet****AE02313**

in box: 10 pcs. in ctn: 12\*10 pcs.

**Tv Antenna Socket****AE02317**

in box: 10 pcs. in ctn: 12\*10 pcs.

**Tv SAT Socket****AE02121**

in box: 10 pcs. in ctn: 12\*10 pcs.

## Anamur golden series



One Way Switch

**AE02401**

in box: 10 pcs. in ctn: 12\*10 pcs.



Two Way Switch

**AE02403**

in box: 10 pcs. in ctn: 12\*10 pcs.



Triple Way Switch

**AE02418**

in box: 10 pcs. in ctn: 12\*10 pcs.



One Way Switch Illuminated

**AE02402**

in box: 10 pcs. in ctn: 12\*10 pcs.



Two Way Switch Illuminated

**AE02404**

in box: 10 pcs. in ctn: 12\*10 pcs.



Dimmer Switch

**AE02414**

in box: 8 pcs. in ctn: 12\*8 pcs.



Cut Out And One Way Switch

**AE02415**

in box: 10 pcs. in ctn: 12\*10 pcs.



Cut Out One Way Switch Illuminated

**AE02416**

in box: 10 pcs. in ctn: 12\*10 pcs.



One Way Vavien Switch

**AE02419**

in box: 10 pcs. in ctn: 12\*10 pcs.



Two Way Vavien Switch

**AE02420**

in box: 10 pcs. in ctn: 12\*10 pcs.

## Anamur golden series



**Socket Outlet 2Pin**

**AE02405**

in box: 10 pcs. in ctn: 12\*10 pcs.



**Shucko Socket Outlet**

**AE02407**

in box: 10 pcs. in ctn: 12\*10 pcs.



**Shucko Socket Outlet W/Cover**

**AE02409**

in box: 10 pcs. in ctn: 12\*10 pcs.



**Socket Outlet 2Pin Double**

**AE02406**

in box: 7 pcs. in ctn: 12\*7 pcs.



**Double Shucko Socket Outlet**

**AE02408**

in box: 6 pcs. in ctn: 12\*6 pcs.



**Numeric Telephone Socket**

**AE02410**

in box: 10 pcs. in ctn: 12\*10 pcs.



**Data Socket Outlet**

**AE02412**

in box: 10 pcs. in ctn: 12\*10 pcs.



**Double Numeric Telephone Socket**

**AE02411**

in box: 10 pcs. in ctn: 12\*10 pcs.



**Data+Phone Socket Outlet**

**AE02413**

in box: 10 pcs. in ctn: 12\*10 pcs.



**Tv Antenna Socket**

**AE02417**

in box: 10 pcs. in ctn: 12\*10 pcs.



**Tv SAT Socket**

**AE02421**

in box: 10 pcs. in ctn: 12\*10 pcs.



## Anamur series Frames

**AE02150**

Double

12 x 20 Pcs.



**AE02151**

Triple

12 x 15 Pcs.



**AE02152**

4 Gang Frame

12 x 12 Pcs.



**AE02153**

5 Gang Frame

12 x 10 Pcs.



**AE02250**

Double

12 x 20 Pcs.



**AE02251**

Triple

12 x 15 Pcs.



**AE02252**

4 Gang Frame

12 x 12 Pcs.



**AE02253**

5 Gang Frame

12 x 10 Pcs.



## Anamur series Frames

**AE02350**

Double

12 x 20 Pcs.

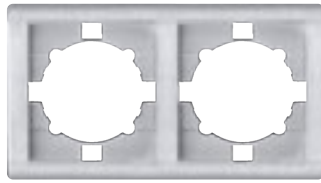
**AE02351**

Triple

12 x 15 Pcs.

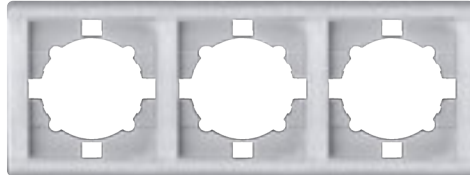
**AE02352**

4 Gang Frame

12 x 12 Pcs.

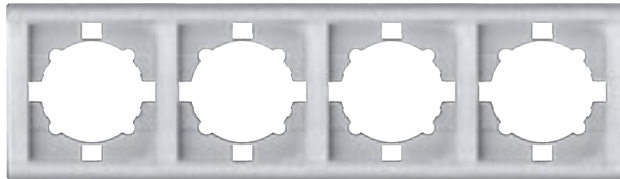
**AE02353**

5 Gang Frame

12 x 10 Pcs.

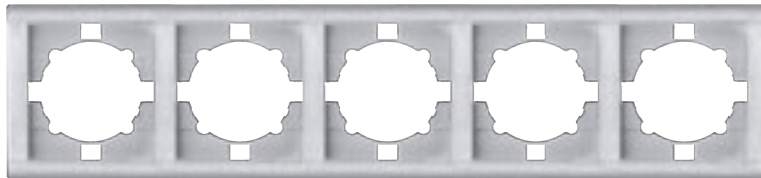
**AE02450**

Double

12 x 20 Pcs.

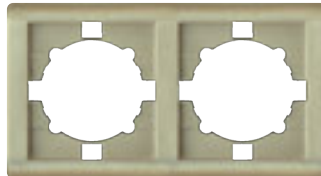
**AE02451**

Triple

12 x 15 Pcs.

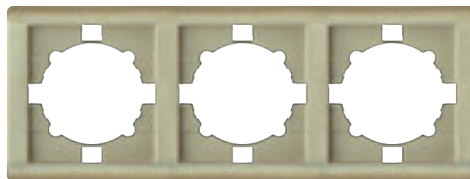
**AE02452**

4 Gang Frame

12 x 12 Pcs.

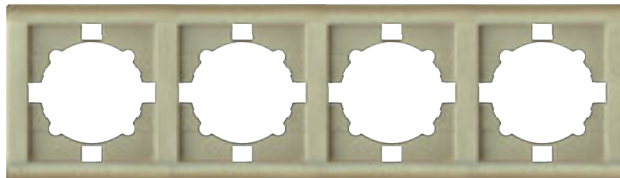
**AE02453**

5 Gang Frame

12 x 10 Pcs.

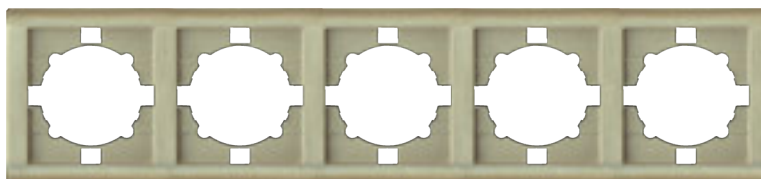

**ANURA**<sup>®</sup>  
ELECTRIC EQUIPMENTS

**KUMLUCA SERIES**



*Fast and easy  
installation.  
Long life  
Elegant Design*

[www.anuraelectric.com](http://www.anuraelectric.com)



## Kumluca white series switch - sockets



**One Way Switch**

**AE20101**

in box: 12 pcs. in ctn: 16\*12 pcs.



**Two Way Switch**

**AE20103**

in box: 12 pcs. in ctn: 16\*12 pcs.



**One Way Switch Illuminated**

**AE20102**

in box: 12 pcs. in ctn: 16\*12 pcs.



**Two Way Switch Illuminated**

**AE20104**

in box: 12 pcs. in ctn: 16\*12 pcs.



**Socket Outlet 2Pin**

**AE20105**

in box: 12 pcs. in ctn: 16\*12 pcs.



**Socket Outlet 2Pin Double**

**AE20106**

In box: 10 pcs. in ctn: 12\*10 pcs.



**Shucko Socket Outlet**

**AE20107**

in box: 12 pcs. in ctn: 12\*12 pcs.



**Double Shucko Socket Outlet**

**AE20108**

In box: 10 pcs. in ctn: 12\*10 pcs.



**Shucko Socket W/Cover**

**AE20109**

In box: 12 pcs. in ctn: 12\*12 pcs.



**ANURA**<sup>®</sup>  
ELECTRIC EQUIPMENTS

ALANYA SERIES



*Fast and easy  
installation.  
Long life  
Elegant Design*

[www.anuraelectric.com](http://www.anuraelectric.com)



## Alanya white series switch - sockets



**One Way Switch  
AE21101**

in box: 12 pcs. in ctn: 16\*12 pcs.



**Two Way Switch  
AE21103**

in box: 12 pcs. in ctn: 16\*12 pcs.



**One Way Vavien Switch  
AE21119**

in box: 12 pcs. in ctn: 16\*12 pcs.



**Cutout One Way  
AE21115**

in box: 12 pcs. in ctn: 16\*12 pcs.



**One Way Switch Illuminated  
AE21102**

in box: 12 pcs. in ctn: 16\*12 pcs.



**Two Way Switch Illuminated  
AE21104**

In box: 12 pcs. in ctn: 16\*12 pcs.



**Socket 2Pin  
AE21105**

in box: 12 pcs. in ctn: 16\*12 pcs.



**Socket 2Pin Double  
AE21106**

in box: 12 pcs. in ctn: 12\*12 pcs.



**Shucko Socket  
AE21107**

In box: 12 pcs. in ctn: 16\*12 pcs.



**Shucko Socket Double  
AE21108**

in box: 9 pcs. in ctn: 12\*9 pcs.

# Circuit Breakers

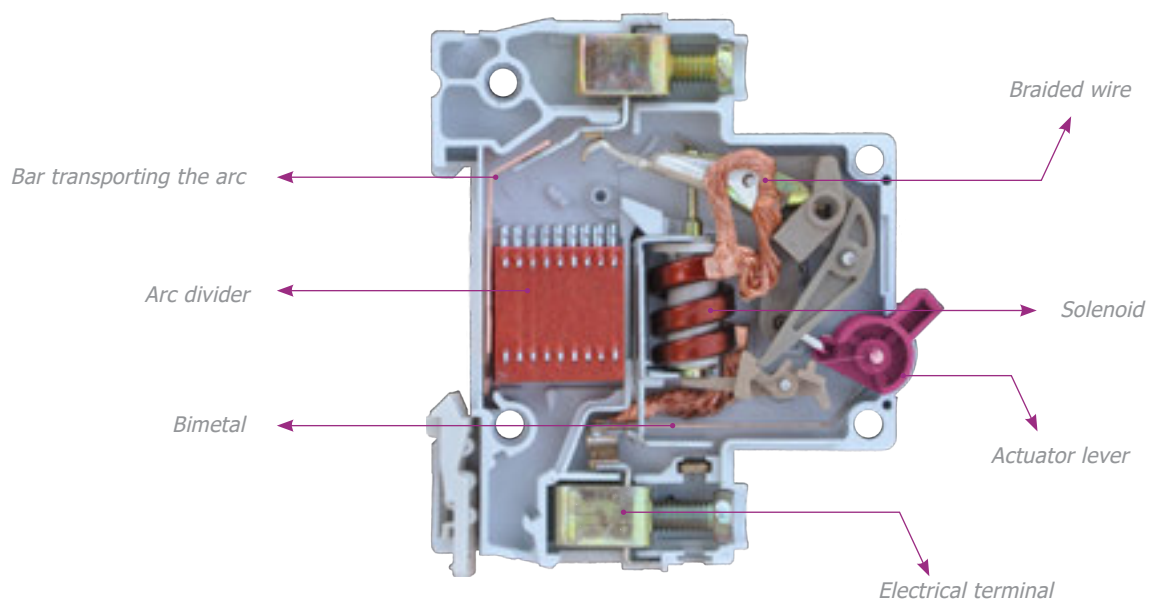
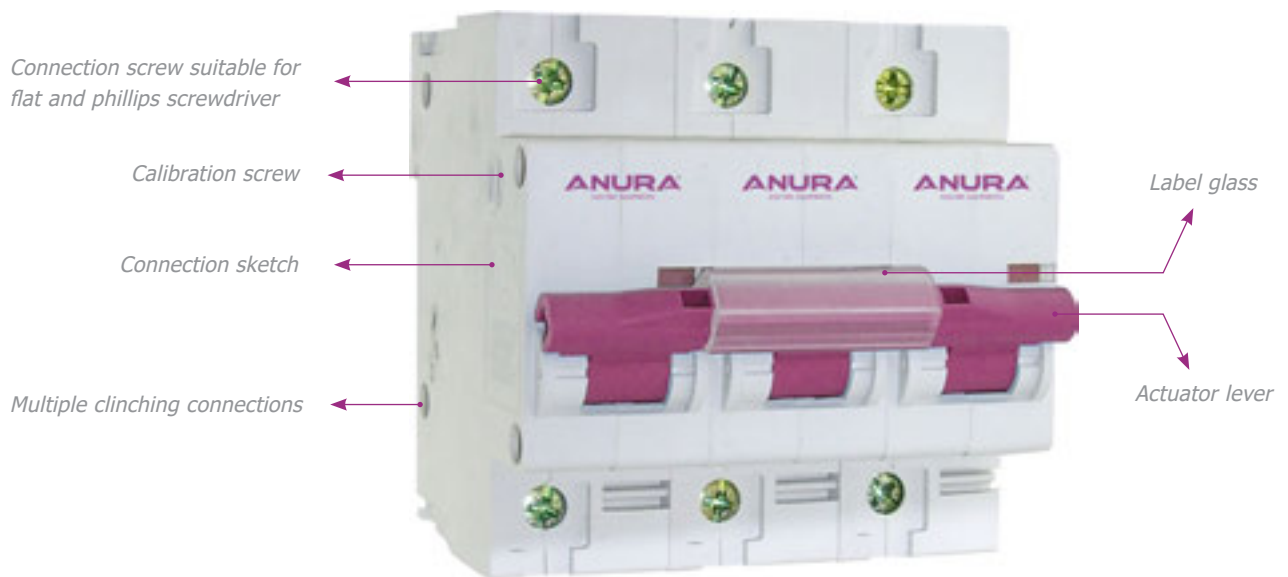



Code	Amper	Description	Pcs
AE40106	6A	1P (4,5kA-AC230~400V-50~60Hz-5Nm~B type)	240
AE40110	10A	1P (4,5kA-AC230~400V-50~60Hz-5Nm~B type)	240
AE40116	16A	1P (4,5kA-AC230~400V-50~60Hz-5Nm~B type)	240
AE40120	20A	1P (4,5kA-AC230~400V-50~60Hz-5Nm~B type)	240
AE40125	25A	1P (4,5kA-AC230~400V-50~60Hz-5Nm~B type)	240
AE40132	32A	1P (4,5kA-AC230~400V-50~60Hz-5Nm~B type)	240
AE40140	40A	1P (4,5kA-AC230~400V-50~60Hz-5Nm~B type)	240
AE40150	50A	1P (4,5kA-AC230~400V-50~60Hz-5Nm~B type)	240
AE40163	63A	1P (4,5kA-AC230~400V-50~60Hz-5Nm~B type)	240
AE40180	80A	1P (4,5kA-AC230~400V-50~60Hz-8Nm~B type)	160
AE401100	100A	1P (4,5kA-AC230~400V-50~60Hz-8Nm~B type)	160



Code	Amper	Description	Pcs
AE40206	6A	2P (4,5kA-AC230~400V-50~60Hz-7.5Nm~B type)	120
AE40216	16A	2P (4,5kA-AC230~400V-50~60Hz-7.5Nm~B type)	120
AE40225	25A	2P (4,5kA-AC230~400V-50~60Hz-7.5Nm~B type)	120
AE40232	32A	2P (4,5kA-AC230~400V-50~60Hz-7.5Nm~B type)	120
AE40240	40A	2P (4,5kA-AC230~400V-50~60Hz-7.5Nm~B type)	120
AE40250	50A	2P (4,5kA-AC230~400V-50~60Hz-7.5Nm~B type)	120
AE40263	63A	2P (4,5kA-AC230~400V-50~60Hz-7.5Nm~B type)	120
AE40280	80A	2P (4,5kA-AC230~400V-50~60Hz-10Nm~B type)	80
AE402100	100A	2P (4,5kA-AC230~400V-50~60Hz-10Nm~B type)	80



Code	Amper	Description	Pcs
AE40306	6A	3P (4,5kA-AC230~400V-50~60Hz-9Nm~B type)	80
AE40316	16A	3P (4,5kA-AC230~400V-50~60Hz-9Nm~B type)	80
AE40325	25A	3P (4,5kA-AC230~400V-50~60Hz-9Nm~B type)	80
AE40332	32A	3P (4,5kA-AC230~400V-50~60Hz-9Nm~B type)	80
AE40340	40A	3P (4,5kA-AC230~400V-50~60Hz-9Nm~B type)	80
AE40350	50A	3P (4,5kA-AC230~400V-50~60Hz-9Nm~B type)	80
AE40363	63A	3P (4,5kA-AC230~400V-50~60Hz-9Nm~B type)	80
AE40380	80A	3P (4,5kA-AC230~400V-50~60Hz-12Nm~B type)	40
AE403100	100A	3P (4,5kA-AC230~400V-50~60Hz-12Nm~B type)	40
AE403125	125A	3P (4,5kA-AC230~400V-50~60Hz-12Nm~B type)	40



## Accessories



**Grounded Female Plug**

**AE30101**

in box: 12 pcs. in ctn: 16\*12 pcs.



**Grounded Male Plug**

**AE30102**

in box: 12 pcs. in ctn: 16\*12 pcs.



**Grounded Male Plug**

**AE30103**

in box: 12 pcs. in ctn: 16\*12 pcs.



**5 Gang Device Type Plug Socket**

**AE30104**

in box: 12 pcs. in ctn: 16\*12 pcs.



**British Type Grounded Adapter Plug**

**AE30105**

in box: 12 pcs. in ctn: 16\*12 pcs.



**Hand Switch**

**AE30106**

in box: 12 pcs. in ctn: 16\*12 pcs.



**Male Plug**

**AE30107**

in box: 12 pcs. in ctn: 16\*12 pcs.



**Female Plug**

**AE30108**

in box: 12 pcs. in ctn: 16\*12 pcs.



**3 Gang Daisy Plug Socket**

**AE30109**

in box: 12 pcs. in ctn: 16\*12 pcs.



**Single Rubber Plug**

**AE0101**

in box: 12 pcs. in ctn: 16\*12 pcs.



**Single Rubber Portable Socket**

**AE0103**

in box: 12 pcs. in ctn: 16\*12 pcs.



**Single Rubber Wall Mounted Socket**

**AE0104**

in box: 12 pcs. in ctn: 16\*12 pcs.



**2 Gang Rubber Wall Multi Socket**

**AE0105**

in box: 12 pcs. in ctn: 16\*12 pcs.



**3 Gang Rubber Wall Multi Socket**

**AE0106**

in box: 12 pcs. in ctn: 16\*12 pcs.

# ANURA®

ELECTRIC EQUIPMENTS



# Certificates



İstoç Ticaret Merkezi 2416 Sk. AKTEM PLAZA  
13.Kat Bağcılar / İstanbul TÜRKİYE

+90 212 771 04 66

info@aktekLtd.com

www.aktekLtd.com

f t i AktekLtd

# Aktek

FOREIGN TRADE COMPANY